

Op de tast...
elektriciteit



Bij deze tekeningenband
hoort gelijknamige uitleg
in braille of Edu-tekst

Dedicon, 2019 versie 01

328528_1

Dit is een inzage-exemplaar. Kopiëren en vermenigvuldigen is niet toegestaan.
Deze tekening komt uit een Op de Tast boek, uitsluitend te bestellen door of
voor leerlingen met een visuele beperking op <https://educatief.dedicon.nl>

© dedicon

1. Symbolen 1
Batterij

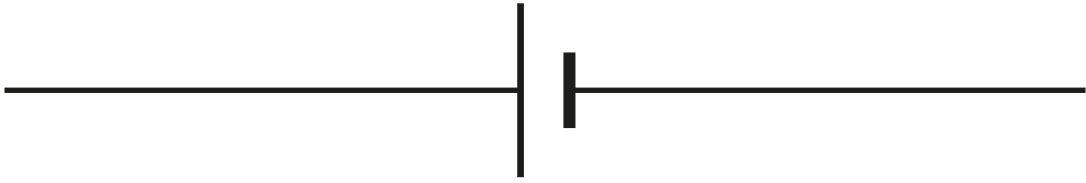

Andere spanningsbron



Lamp

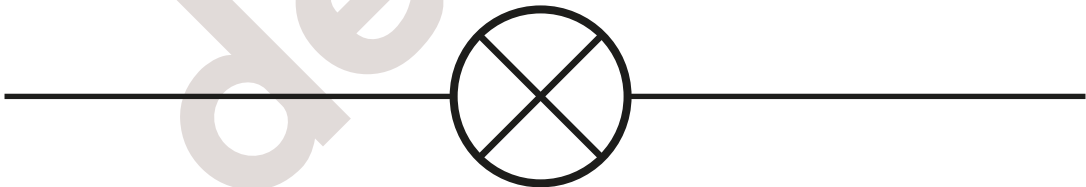

Weerstand



2. Symbolen 2
Aan- uit schakelaar



Drukschakelaar



Wisselschakelaar/tweewegschakelaar

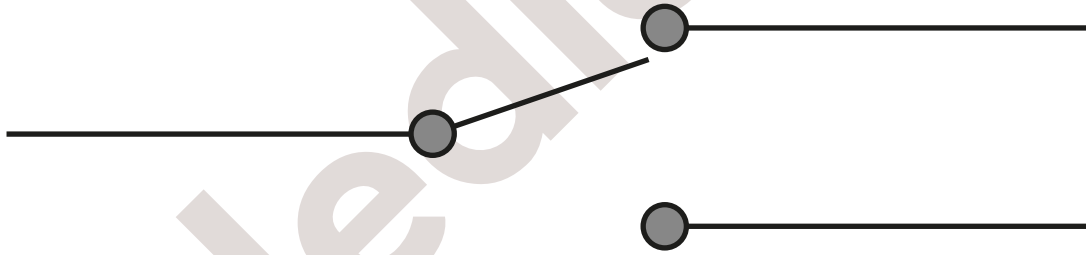

Voltmeter

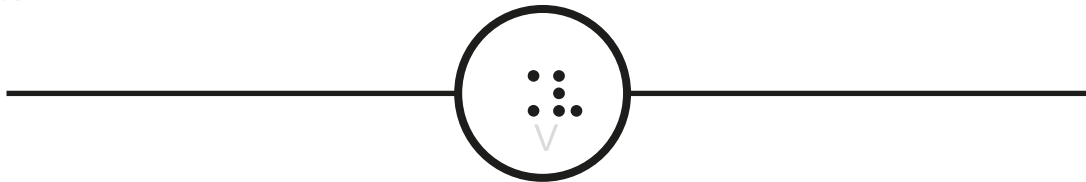

Ampèremeter

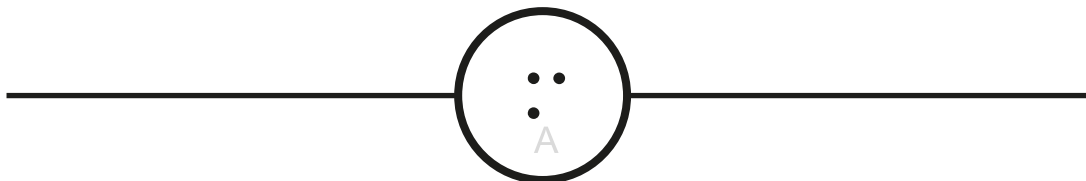

3. Symbolen 3
Diode

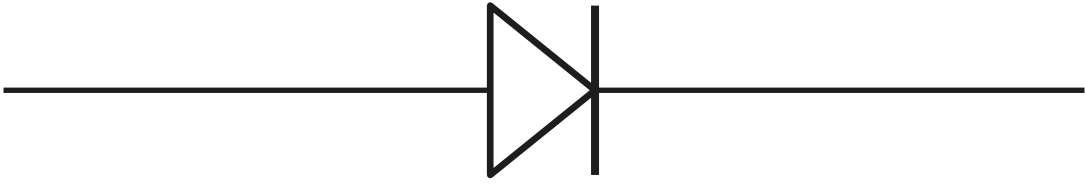

LED

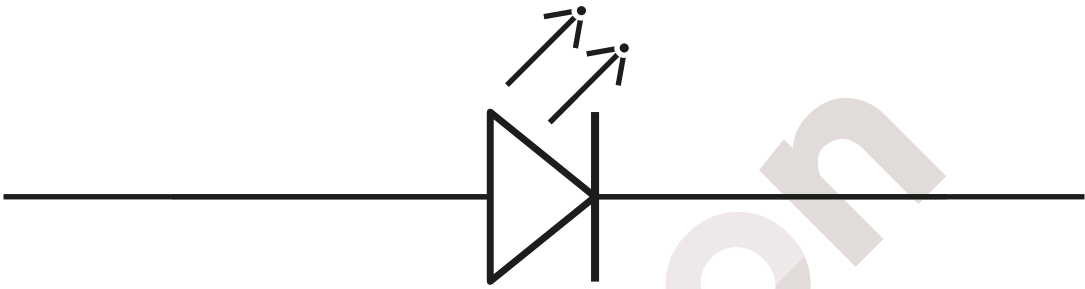

Reedcontact

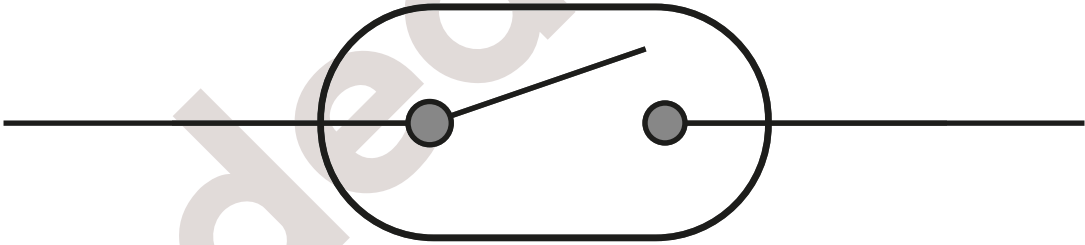

Transistor

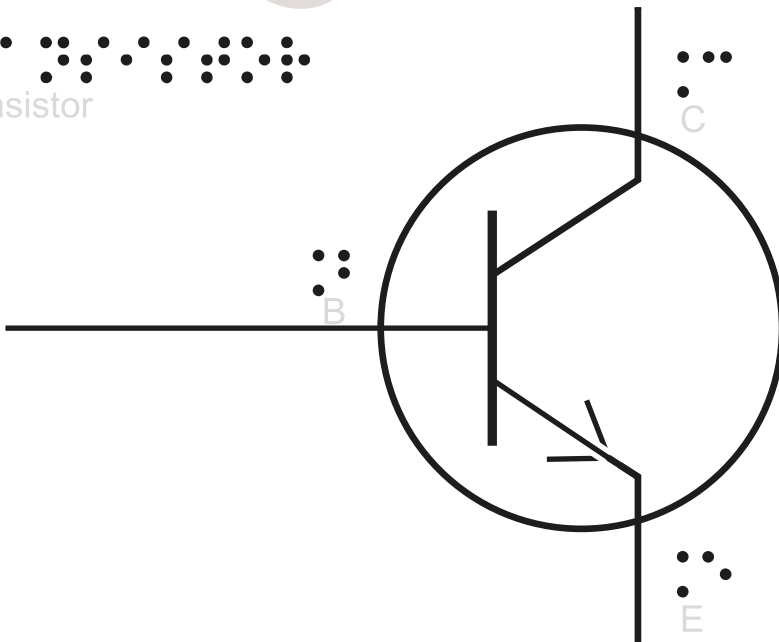

Dit is een inzage-exemplaar. Kopiëren en vermenigvuldigen is niet toegestaan.
Deze tekening komt uit een Op de Tast boek, uitsluitend te bestellen door of
voor leerlingen met een visuele beperking op <https://educatief.dedicon.nl>

4. Symbolen 4
LDR

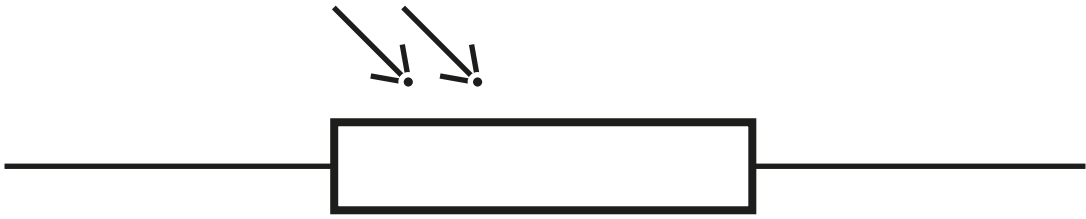

NTC

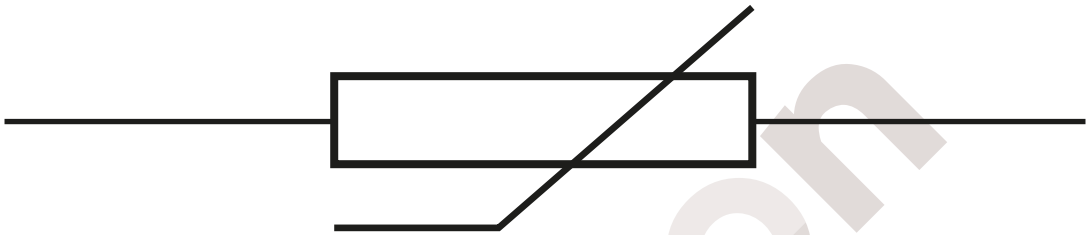

Variabele weerstand

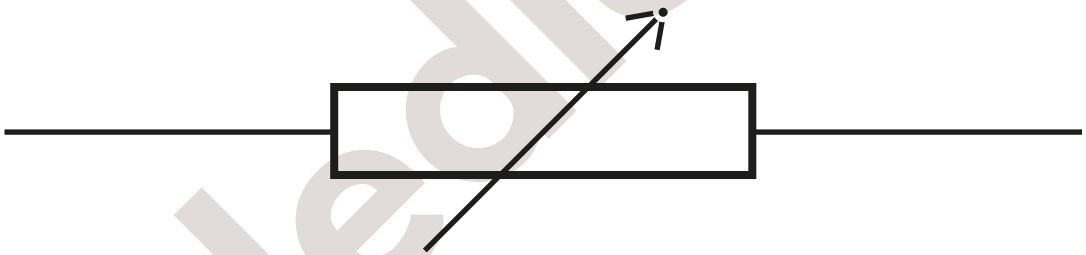

Condensator



Aarde

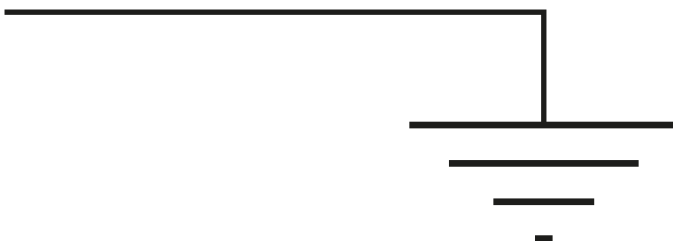

5. Serieschakelingen

a

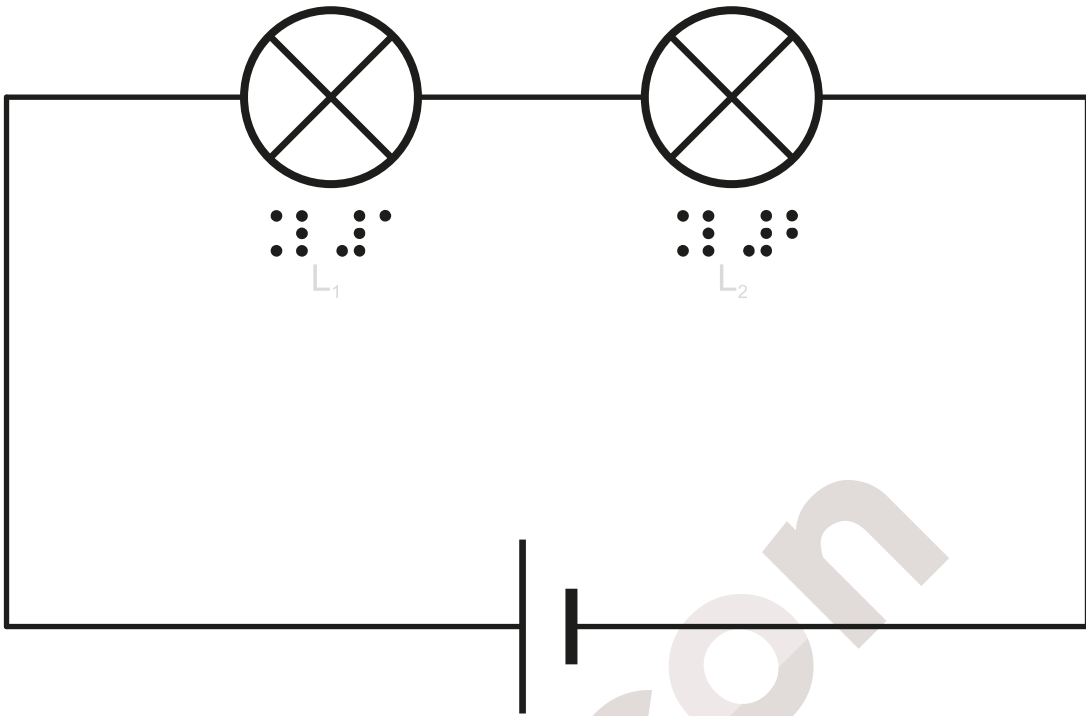

b

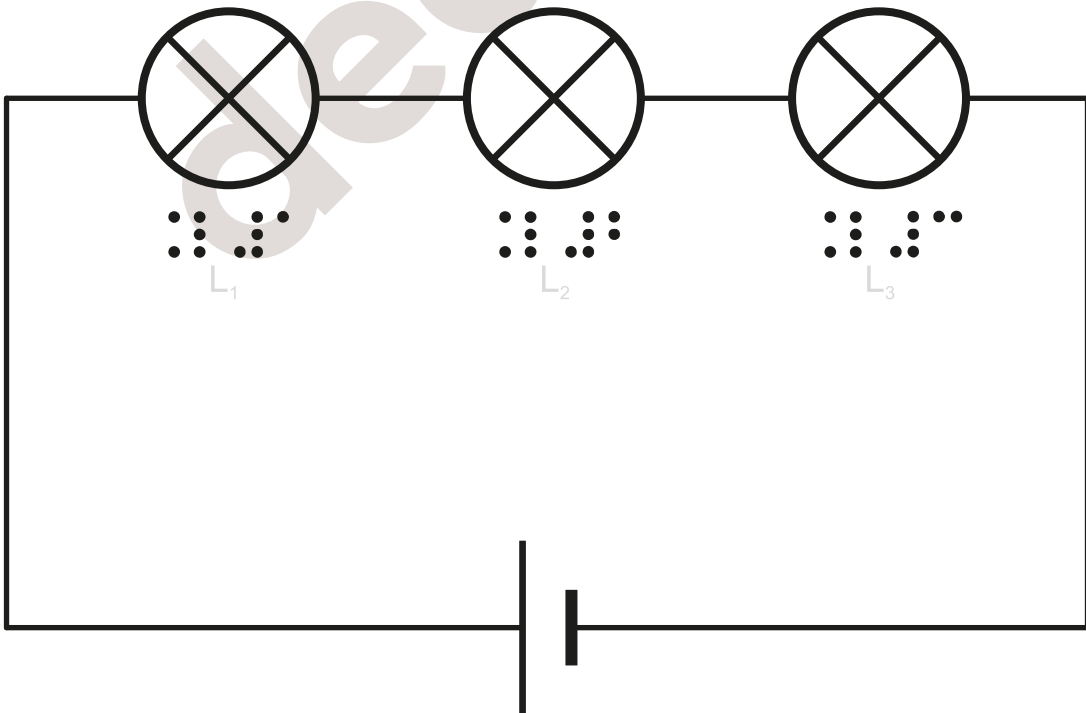

6. Parallelschakelingen

a

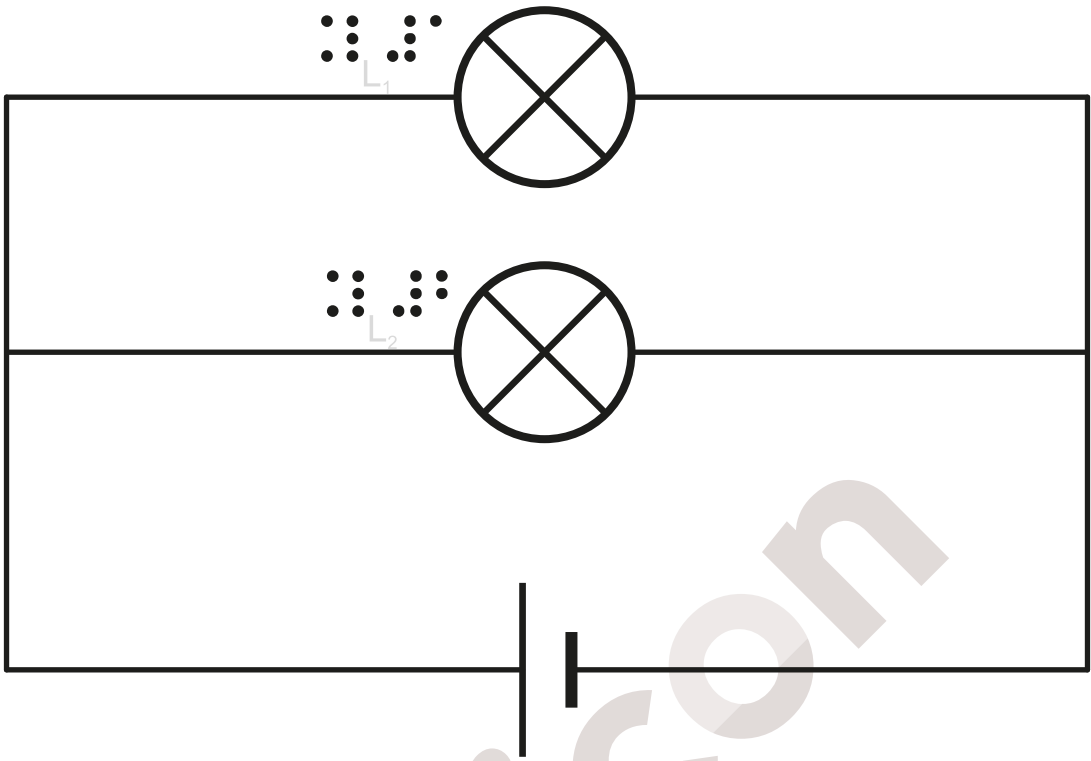

b

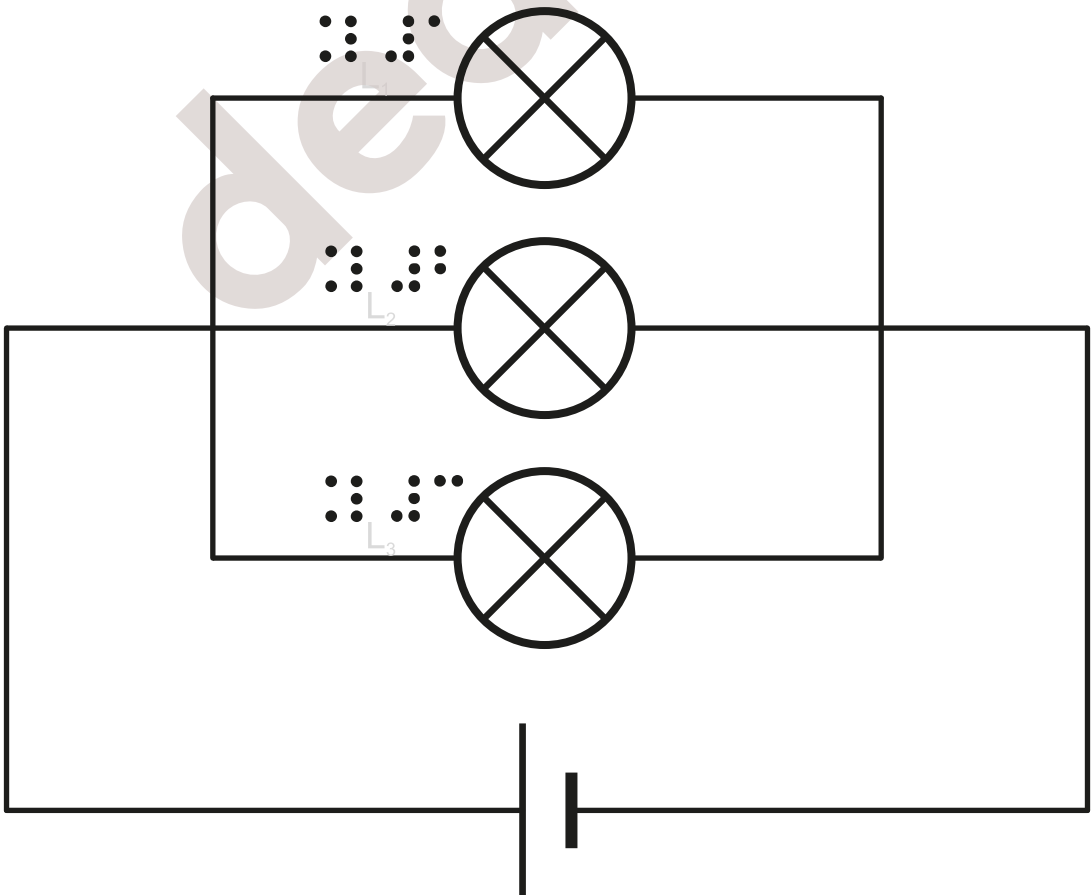

7. Schakelaars 1
a

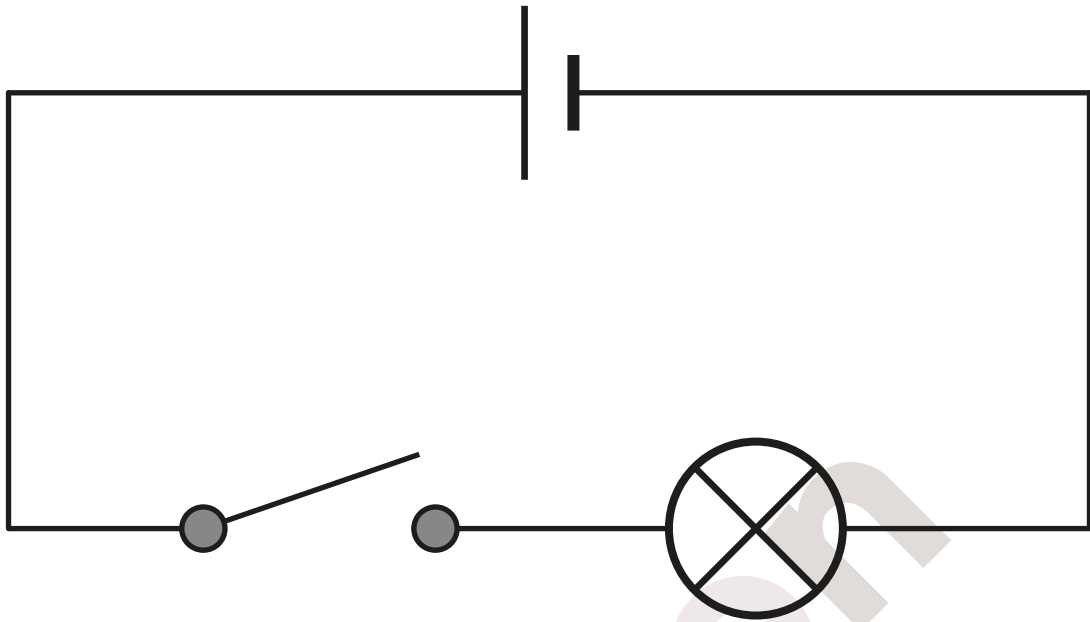

b

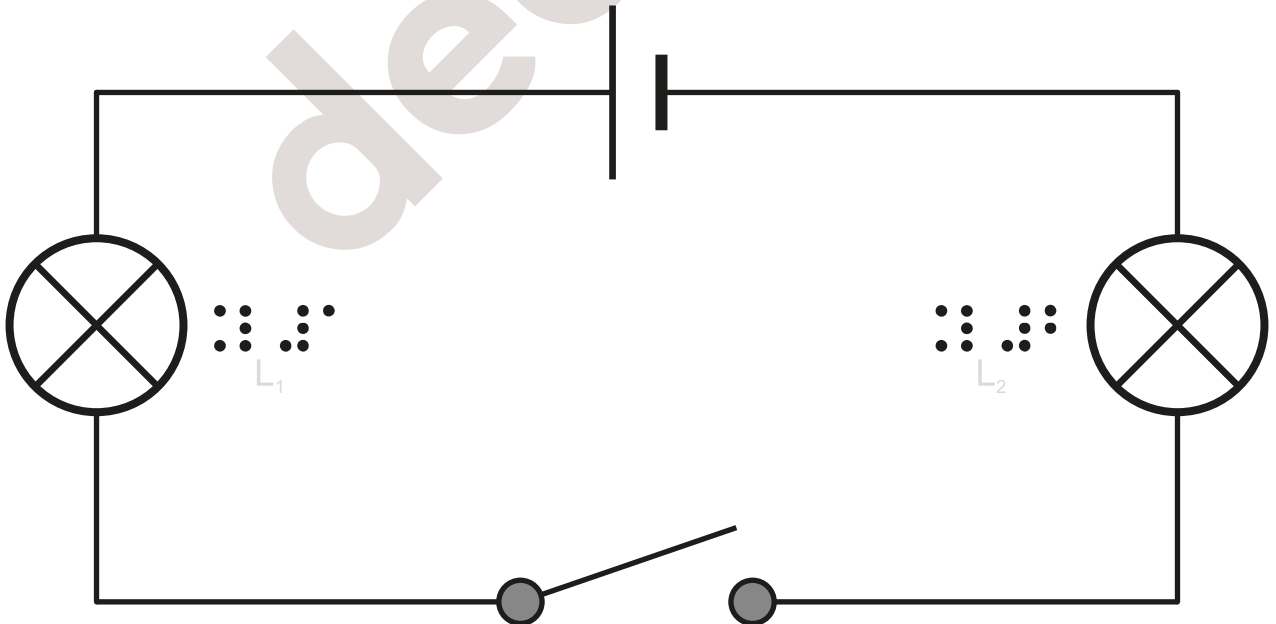

8. Schakelaars 2
a

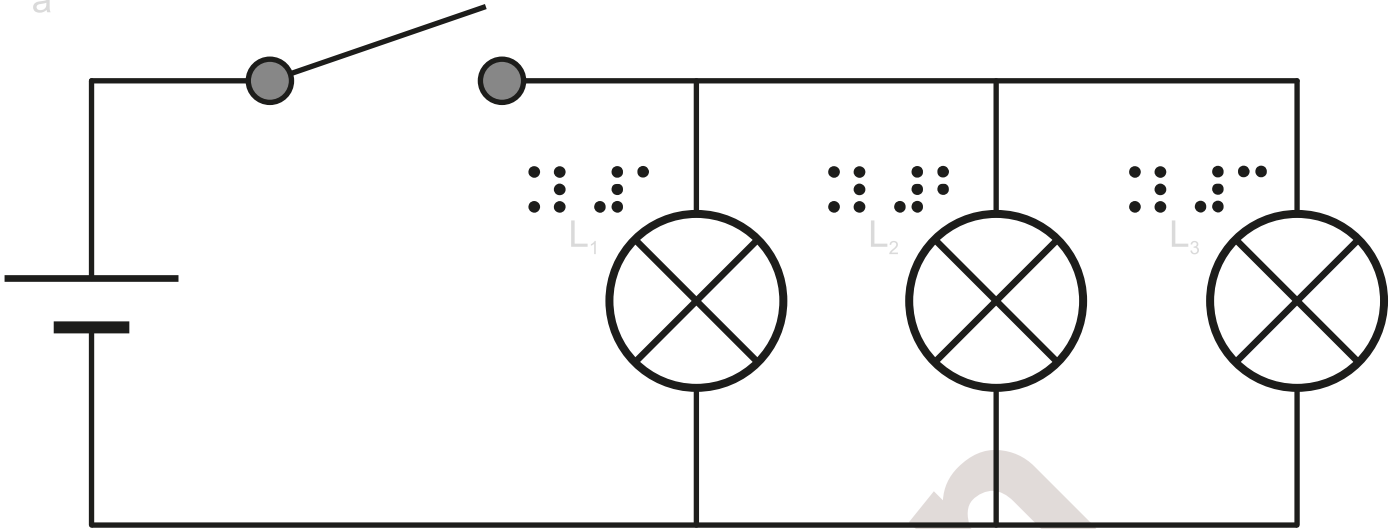

b

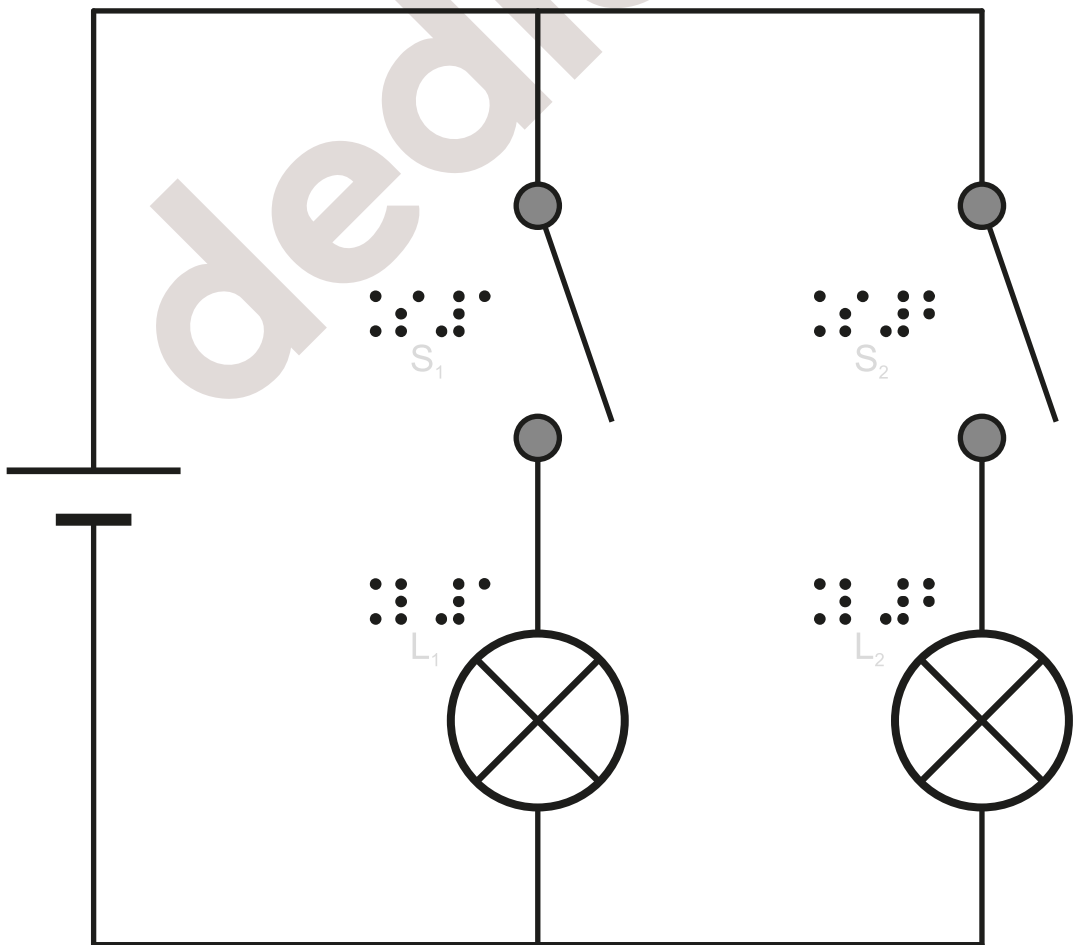

9. Schakelaars 3
a

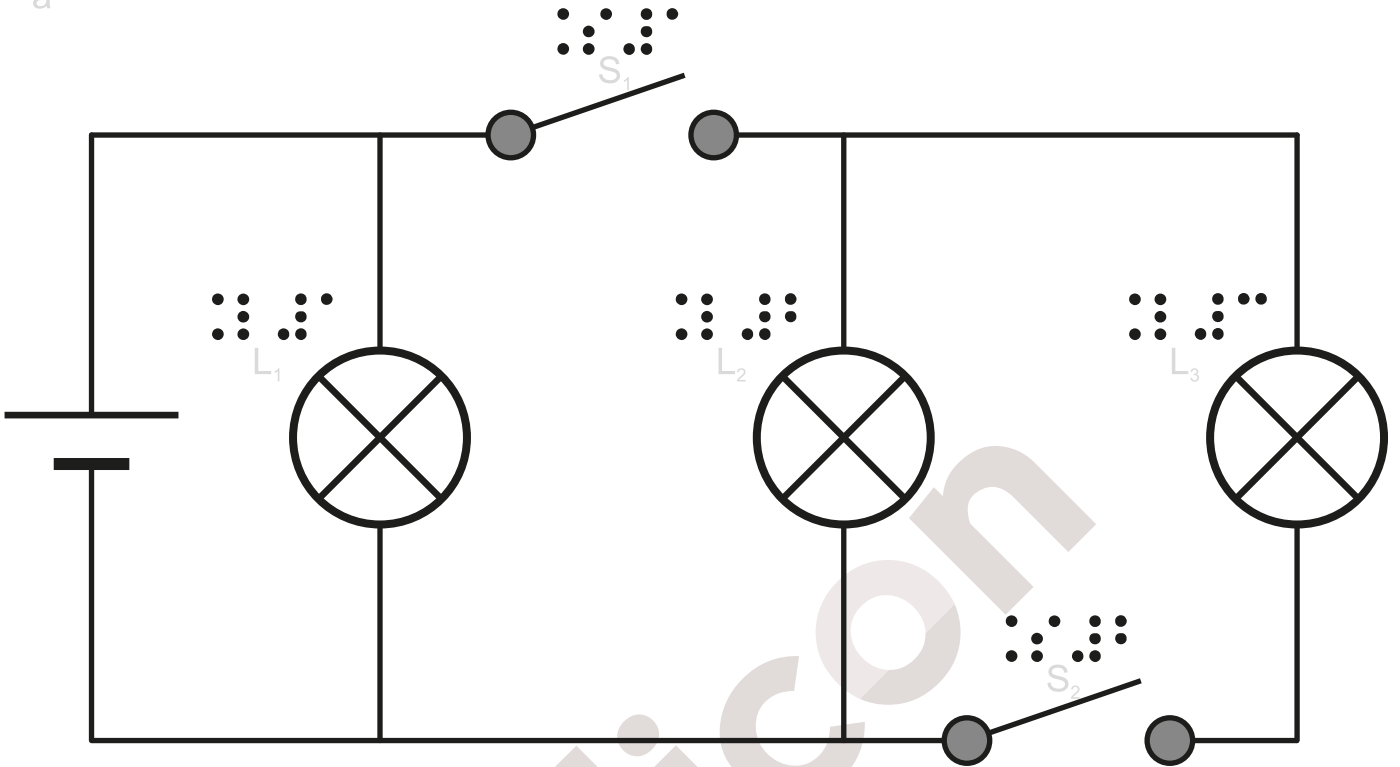

b

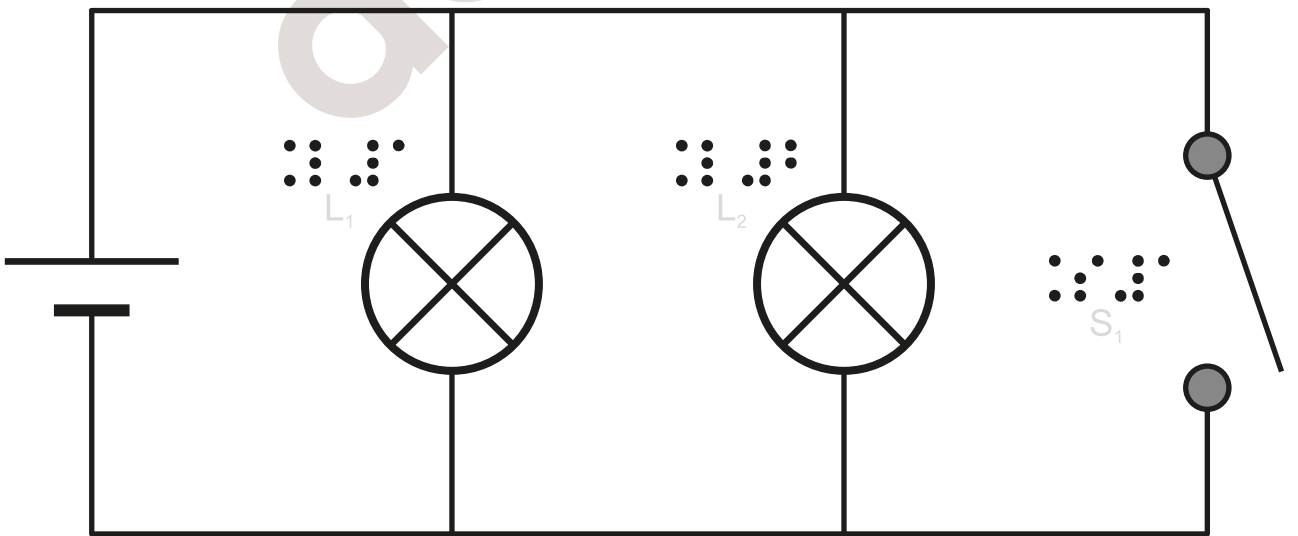

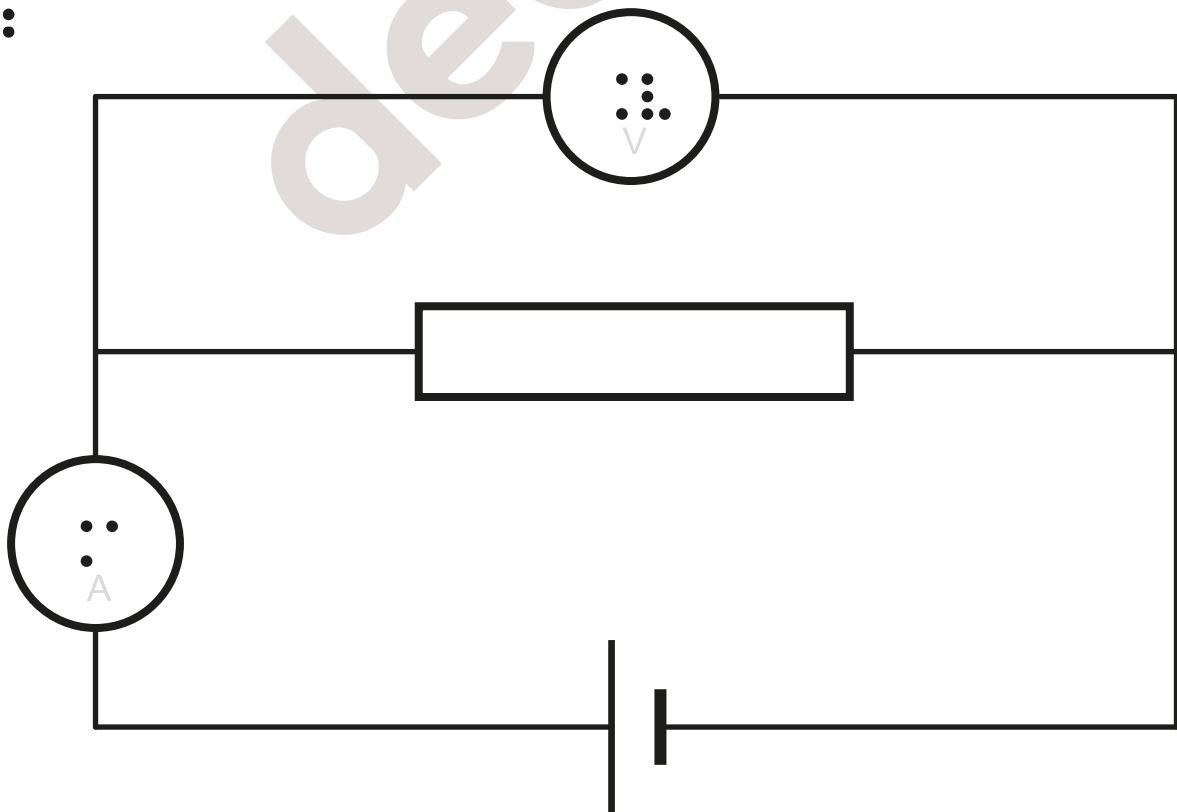
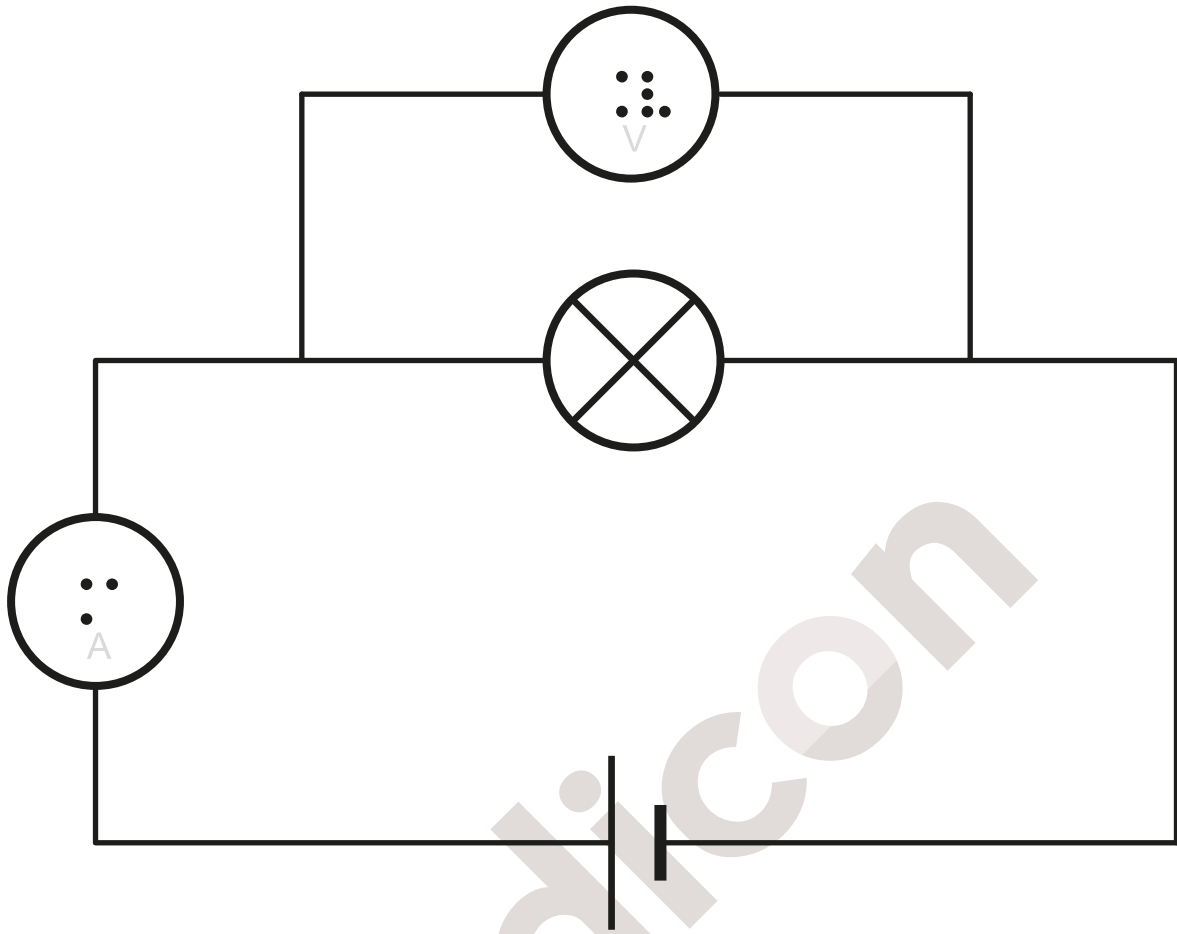

11. Meters 2
a

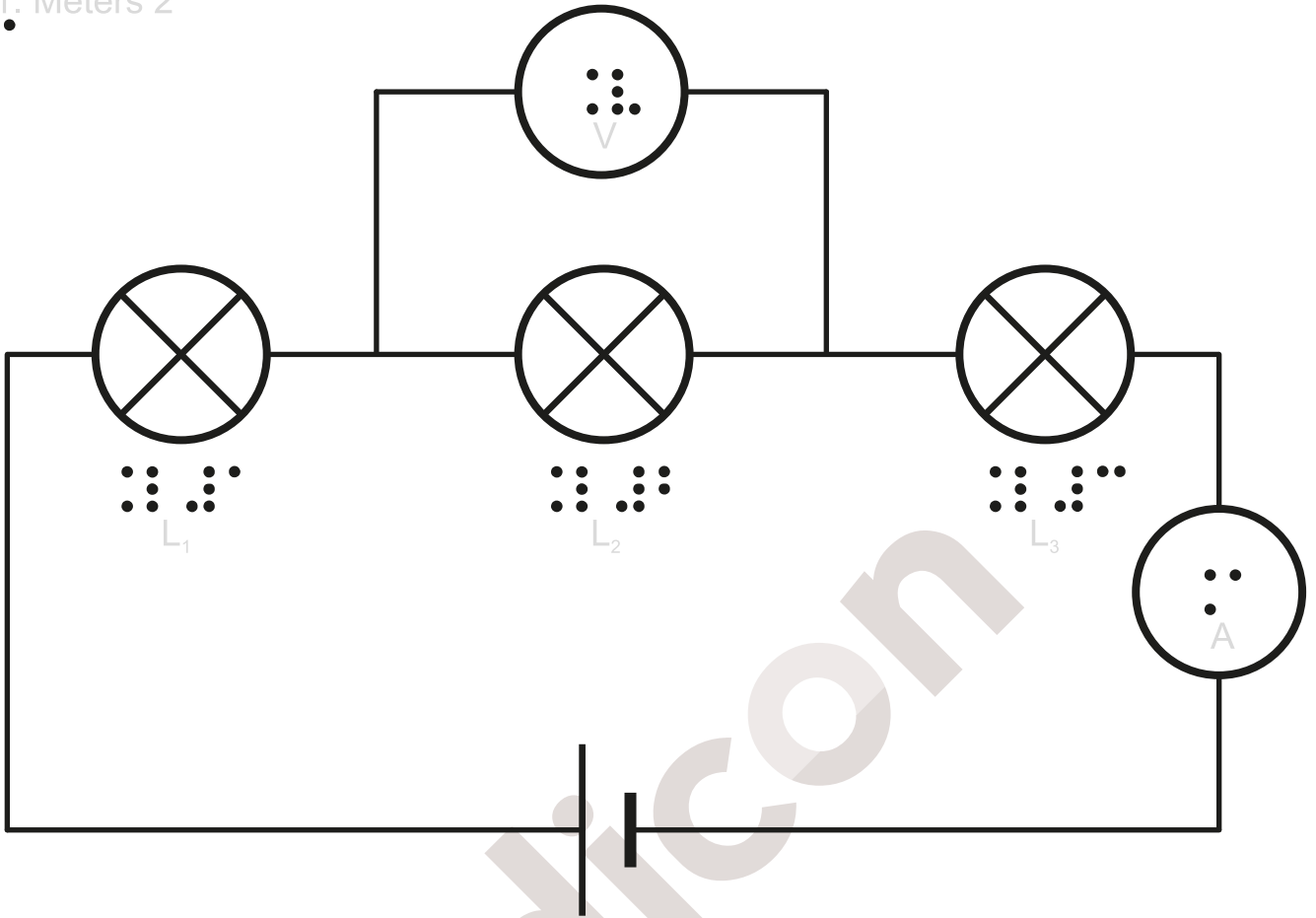

b

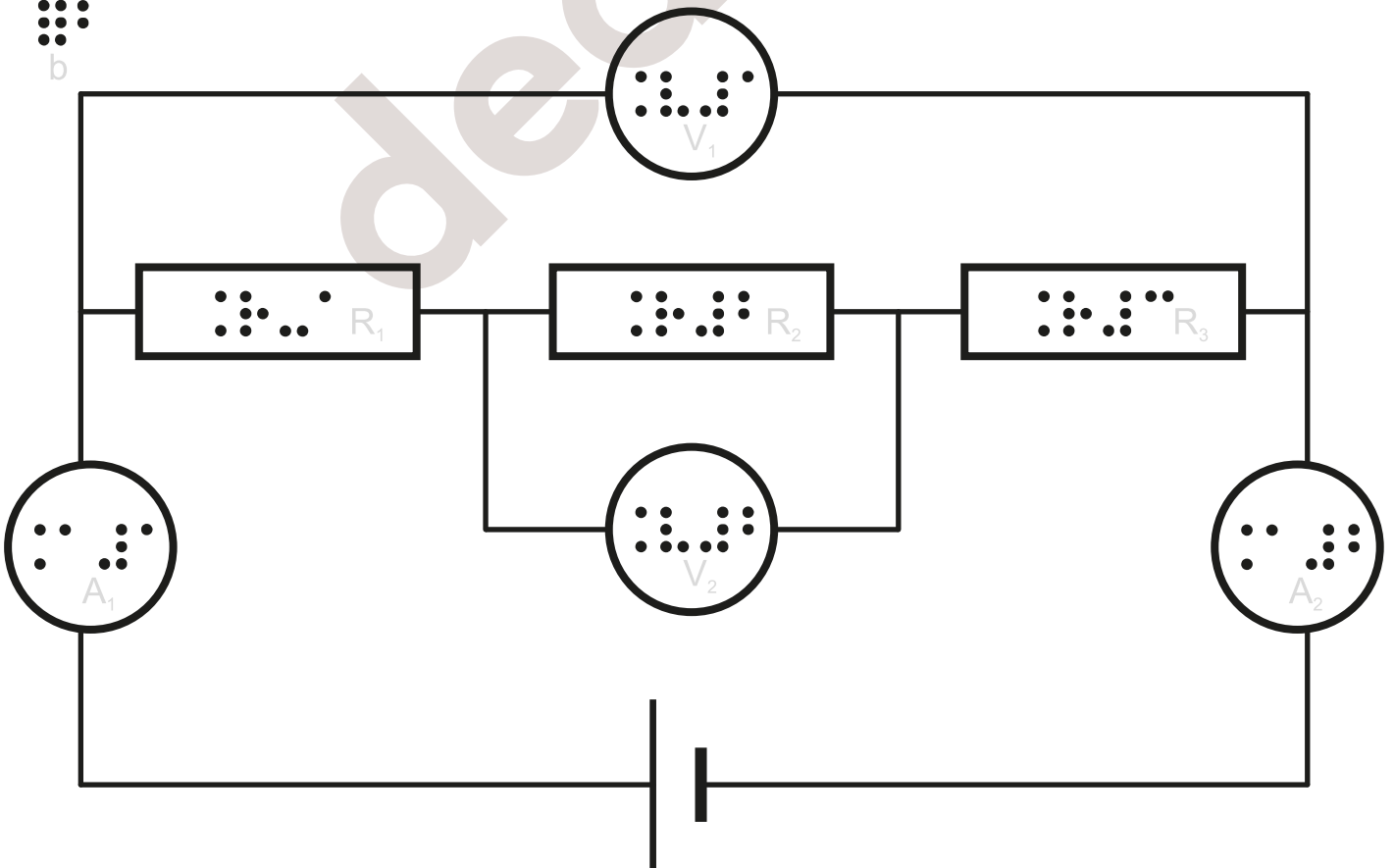

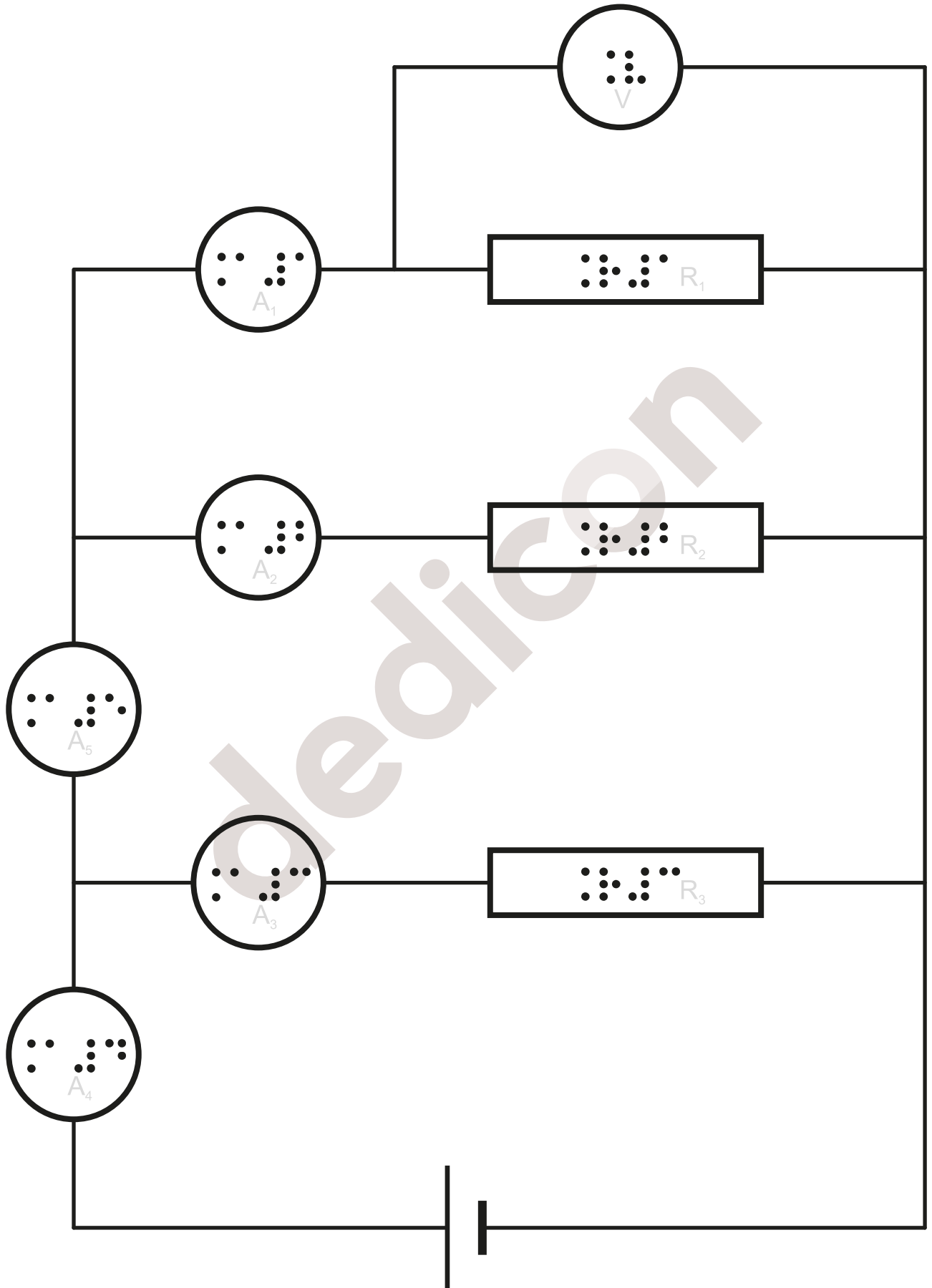

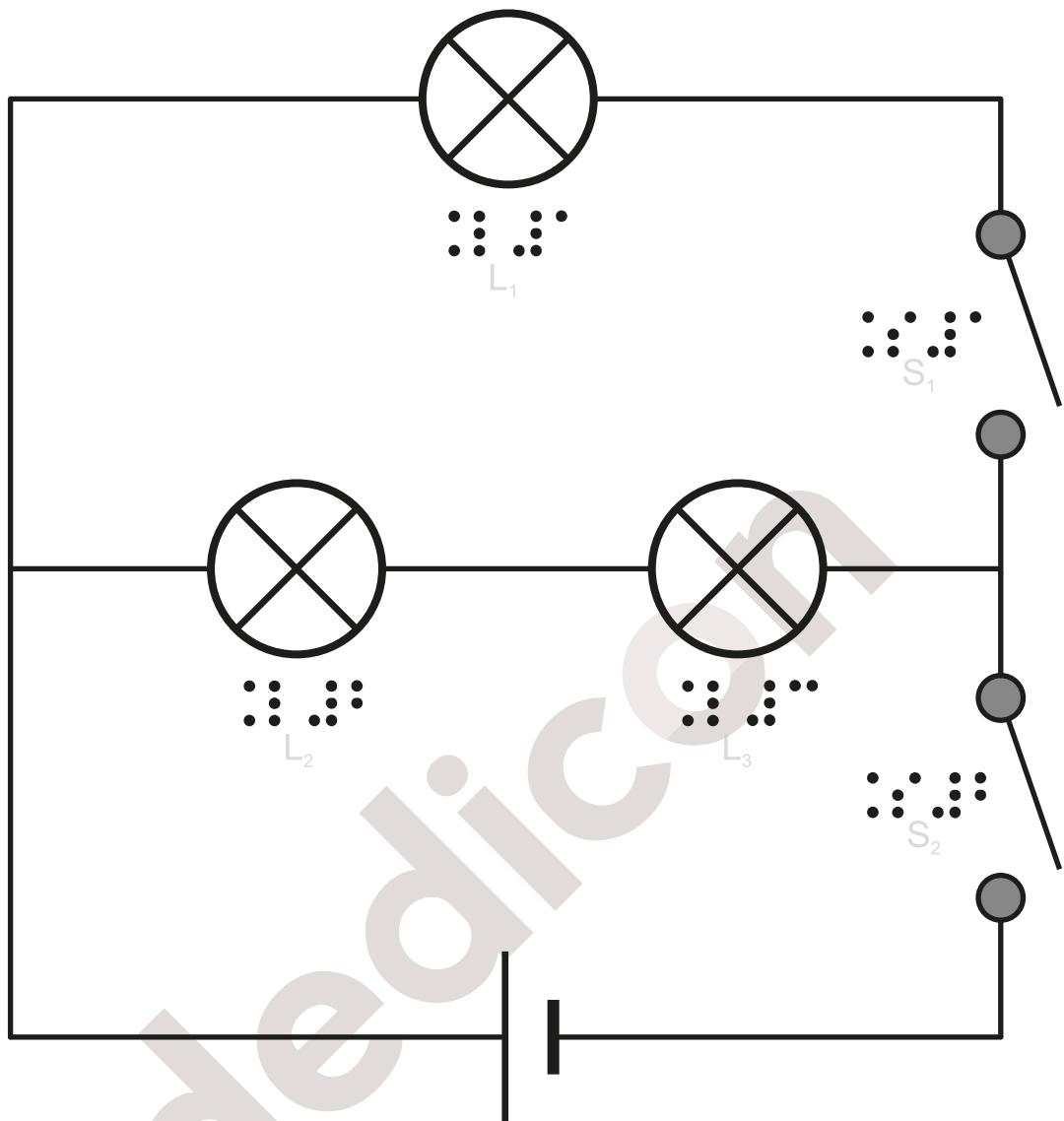

15. Gecombineerde schakelingen 3

a

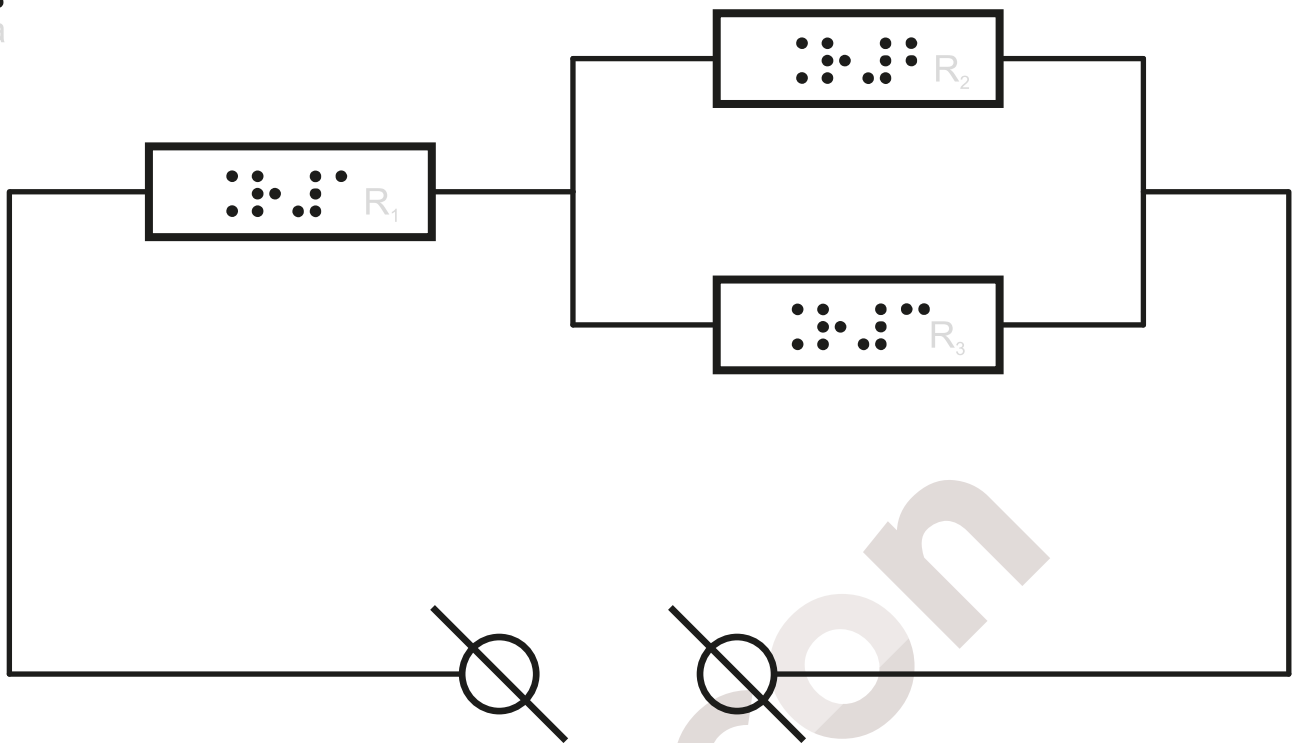

b

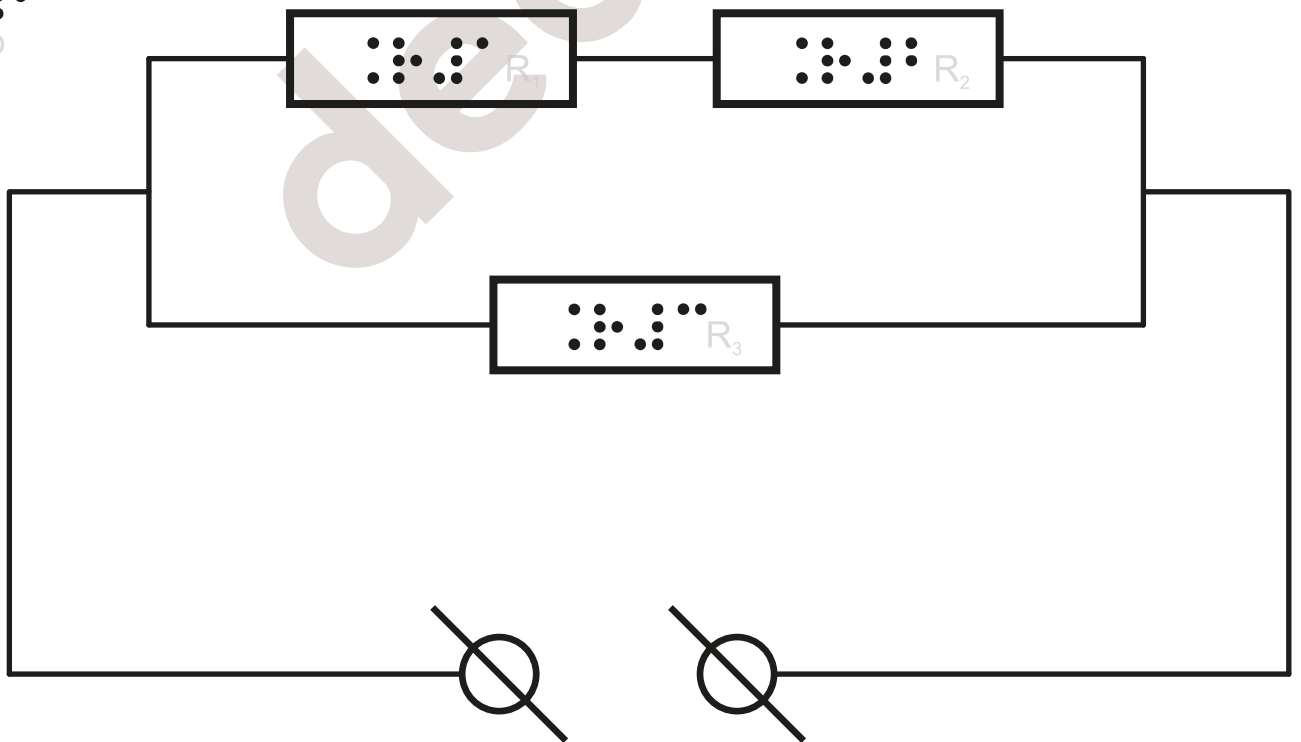

16. Schuifweerstand
a

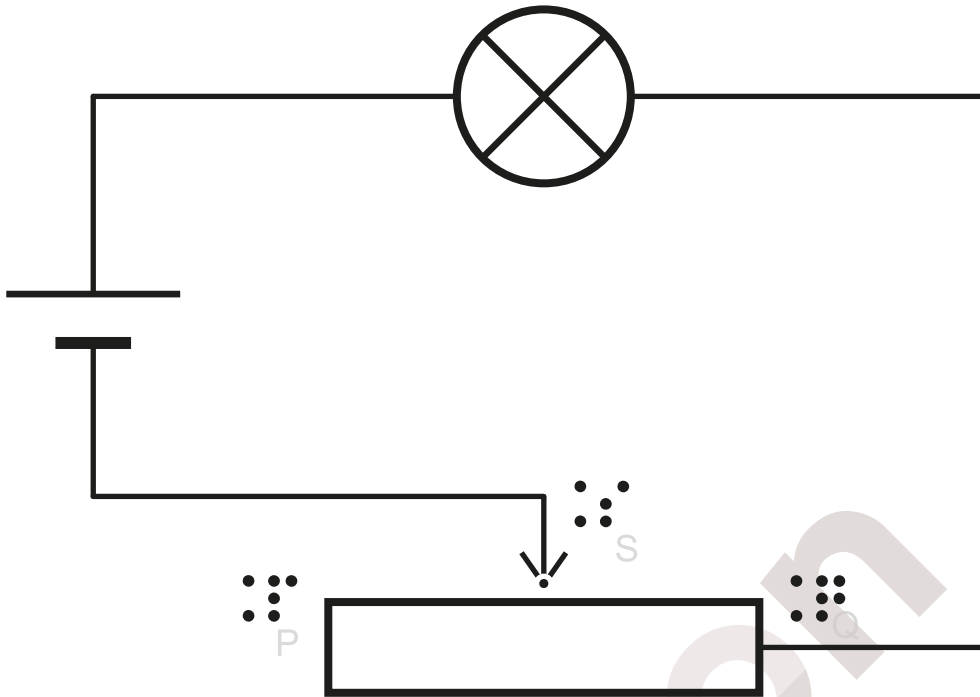

b

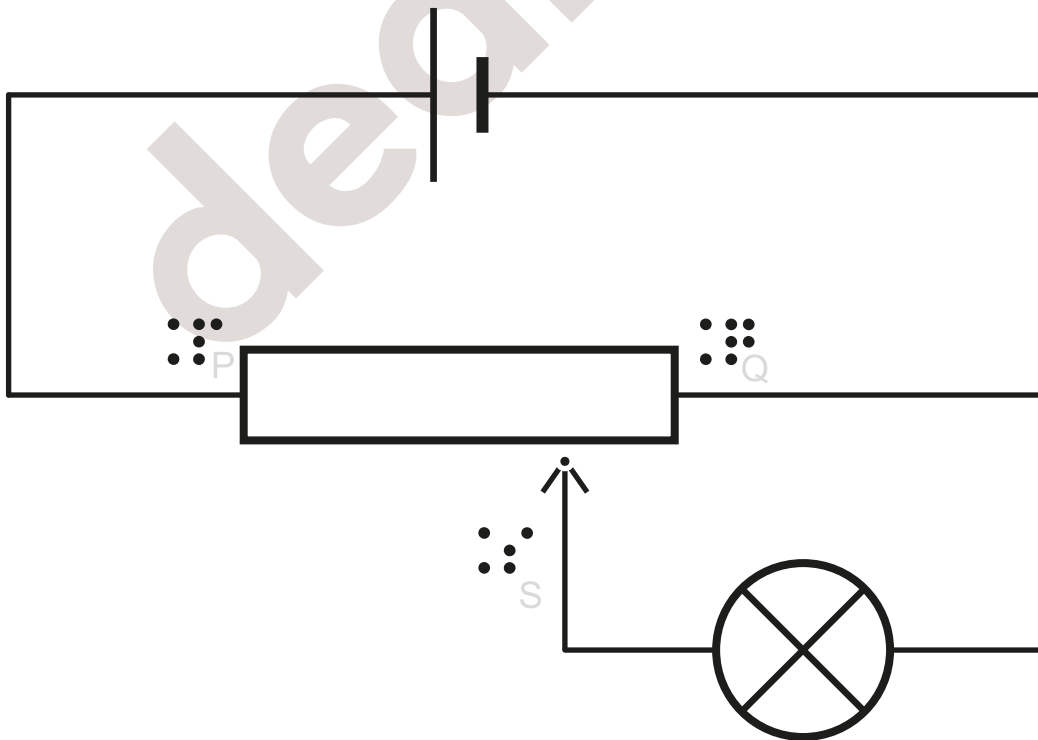

17. Schuifweerstand als spanningsdeler

a

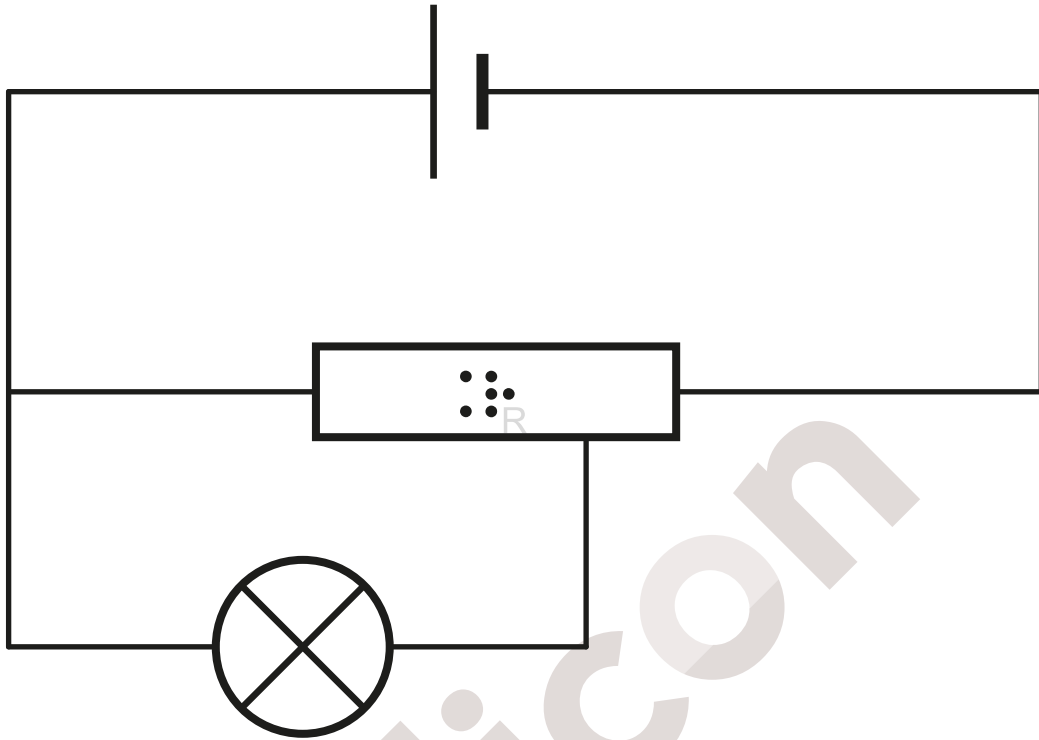

b

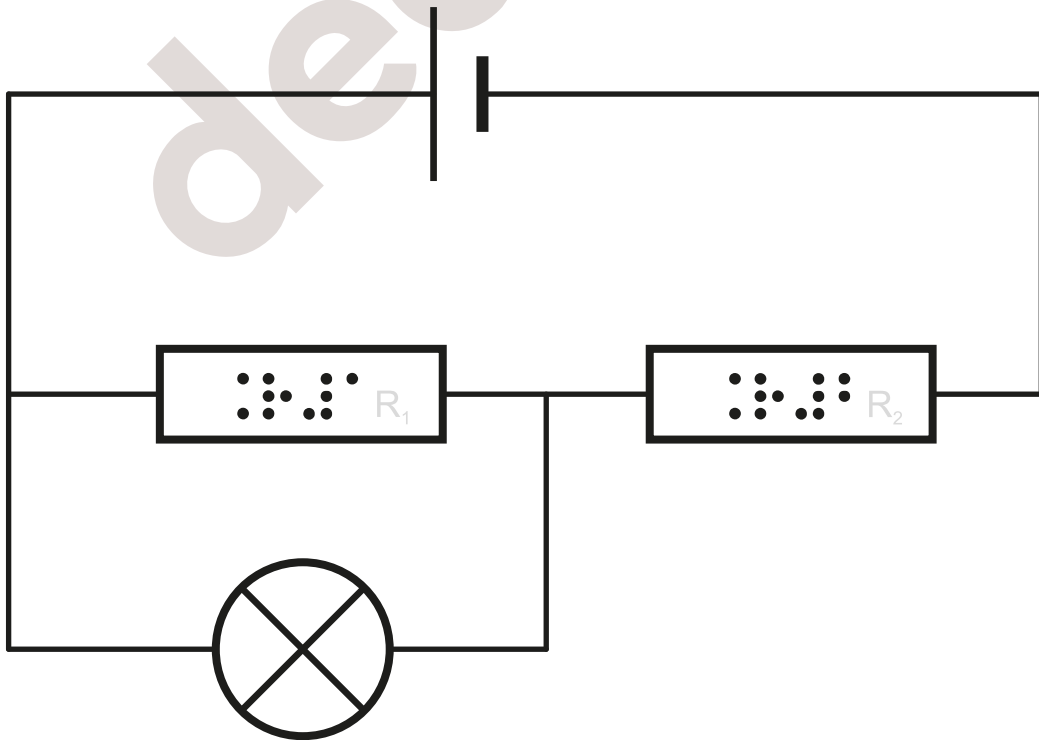

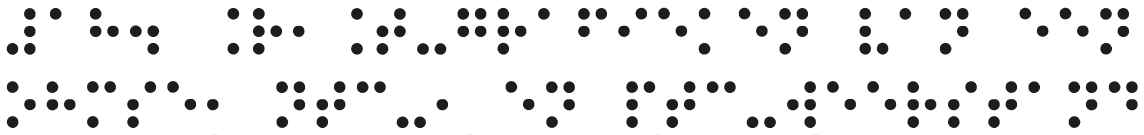

18. R,T-grafieken van een Ohmse, NTC-, en PTC-weerstand

Ohms

R



NTC

R

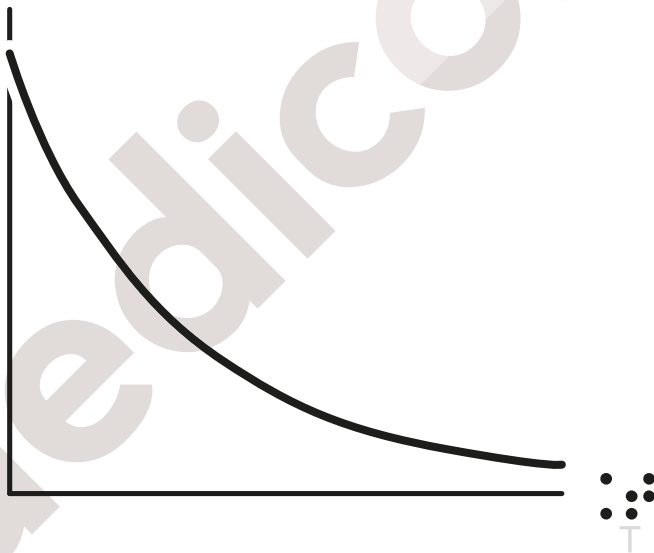

PTC

R

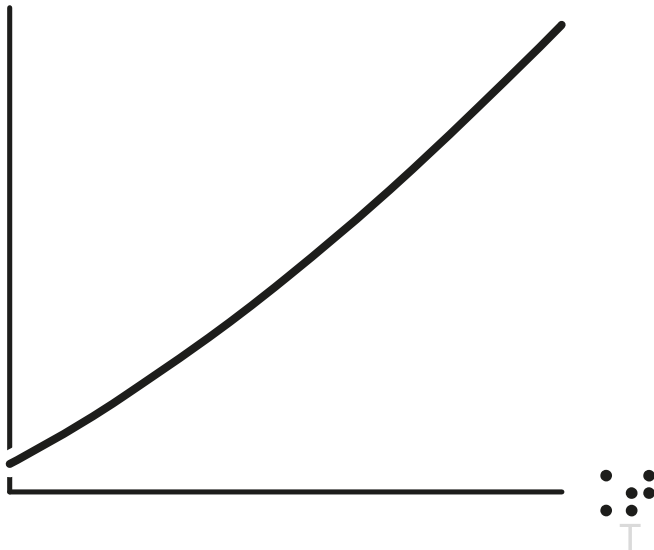

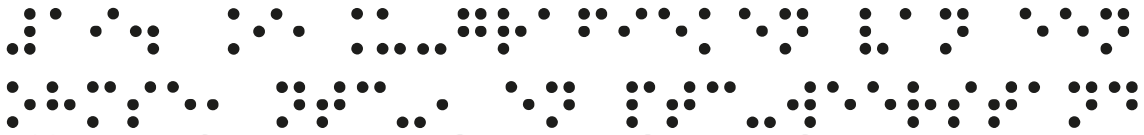

19. I,U-grafieken van een Ohmse, NTC-, en PTC-weerstand

Ohms

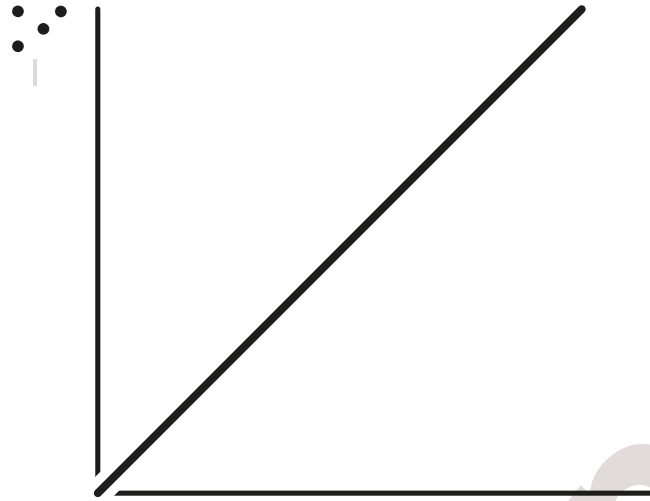

NTC

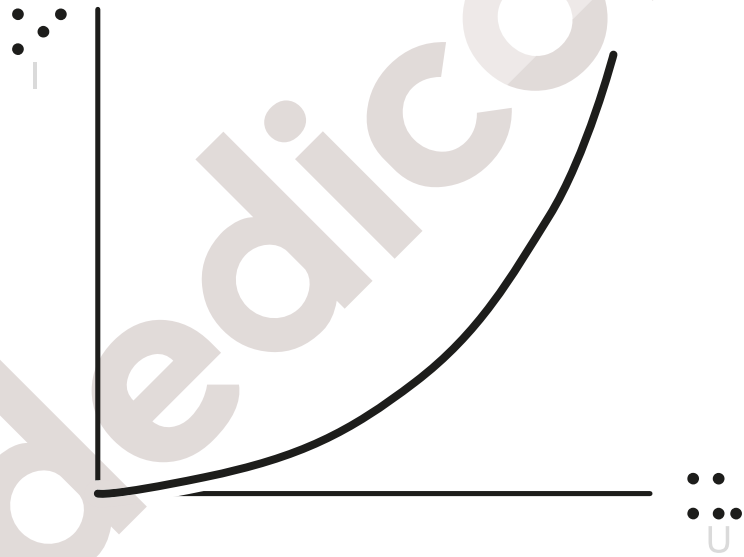

PTC

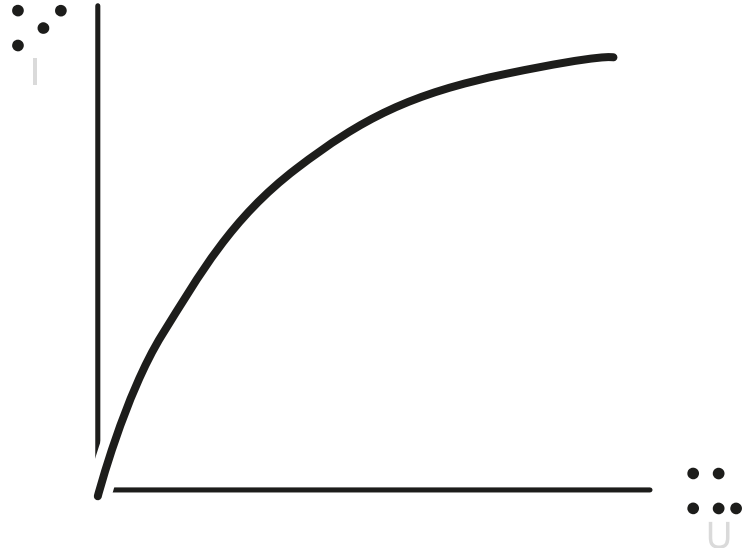

20. I,U-grafiek van een gloeilamp

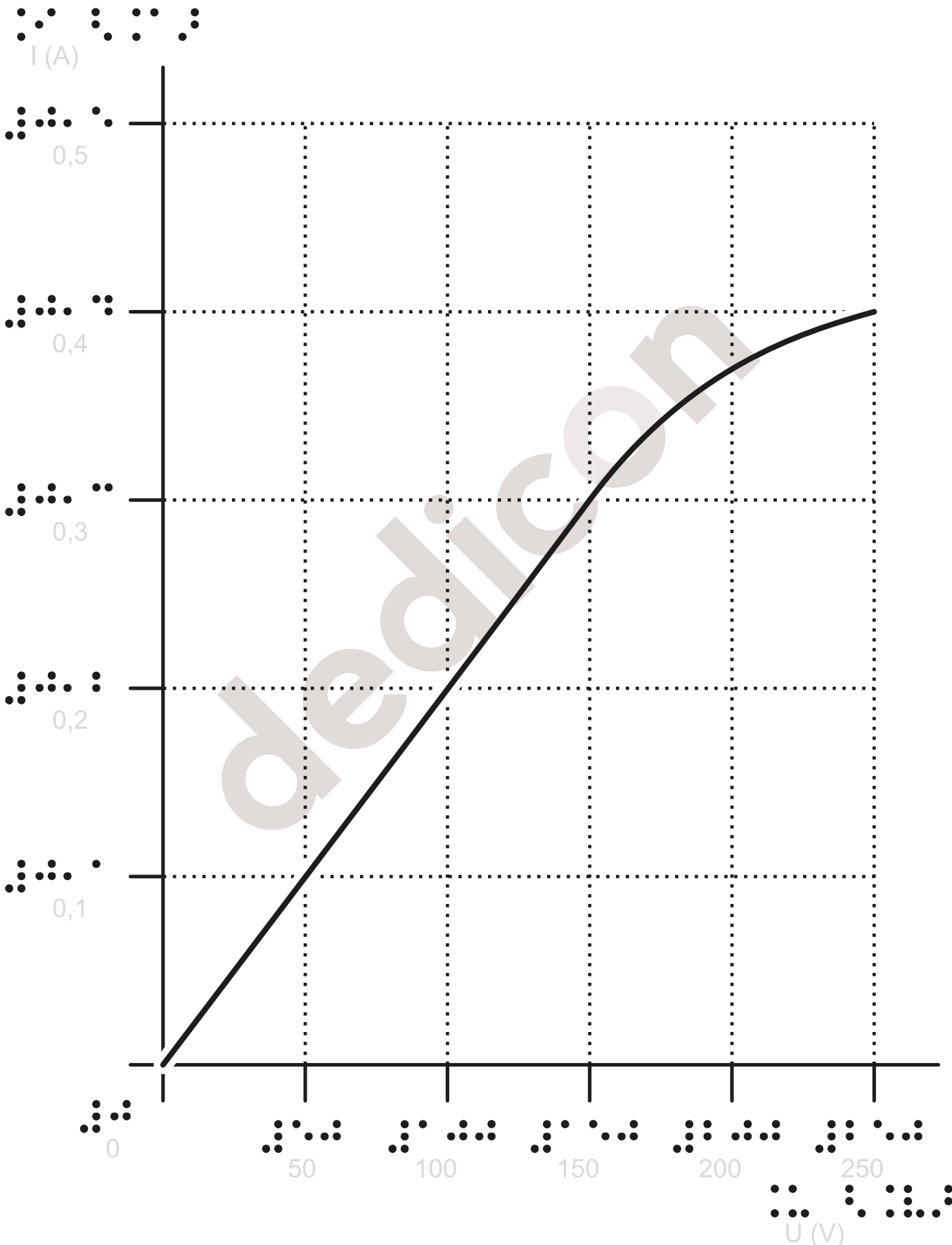



21. I,U-grafiek van een diode

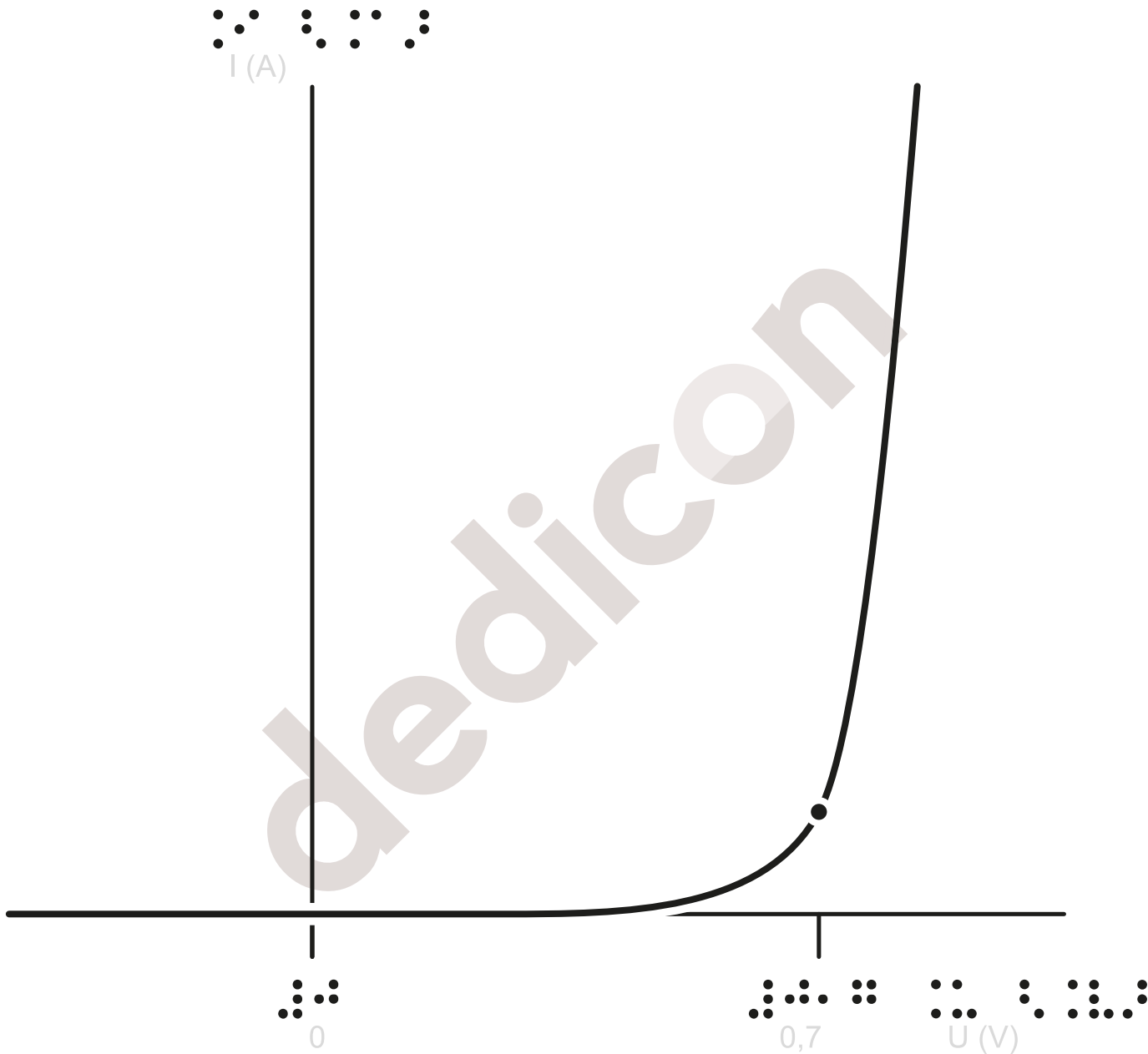

22. R,T-grafiek

R (Ω)

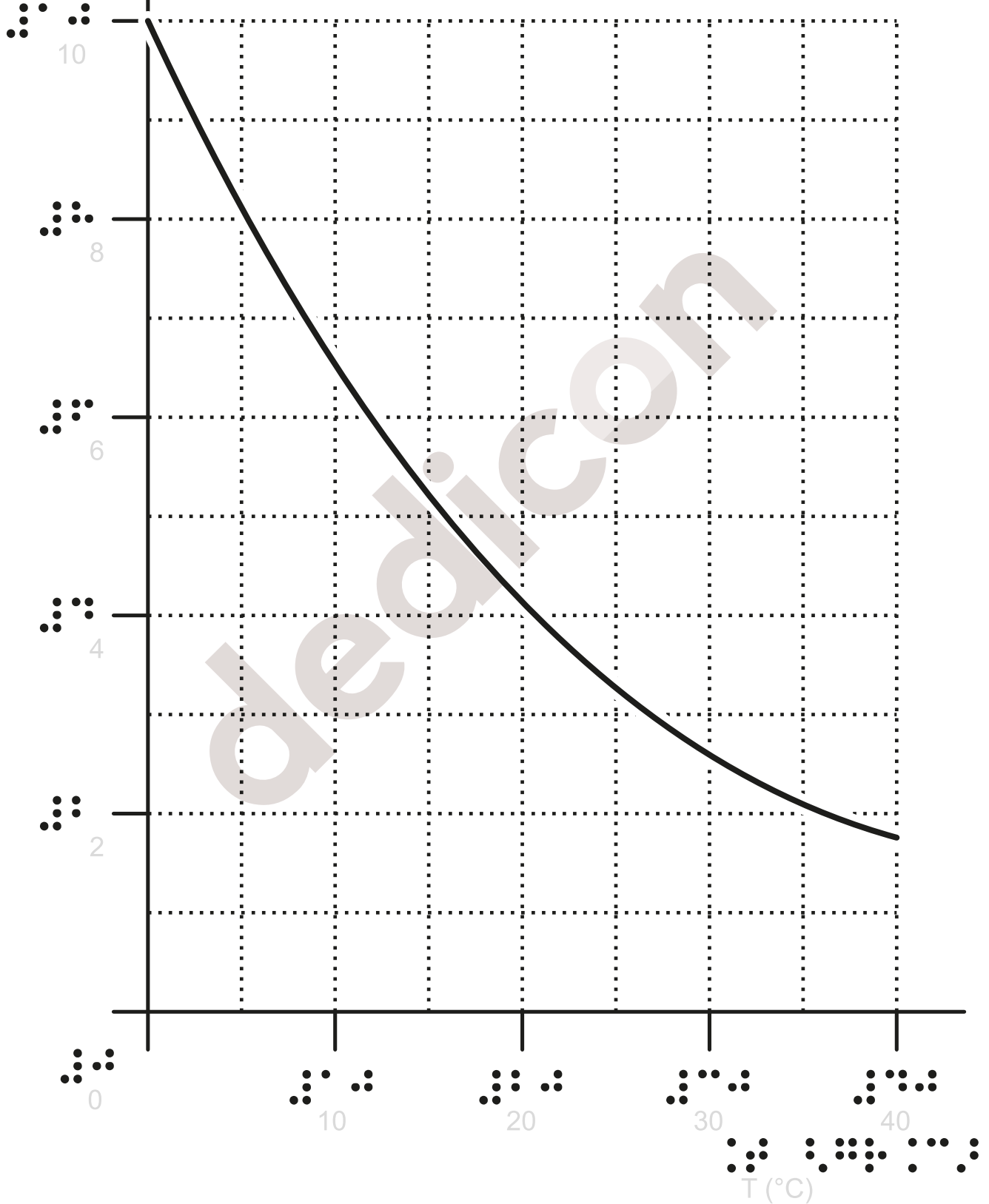

23. I,U-grafiek

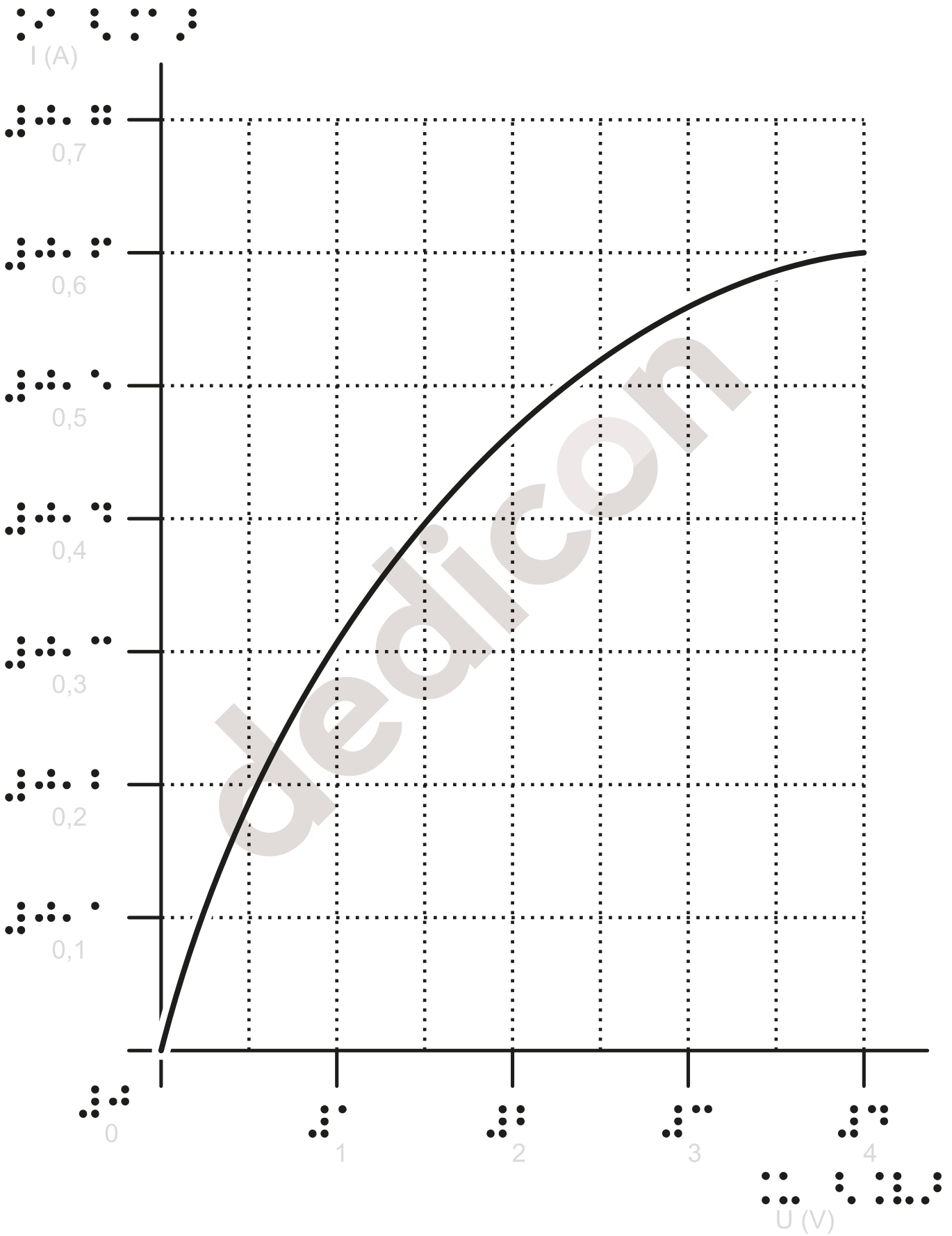

24. R, T-grafiek van een temperatuursensor

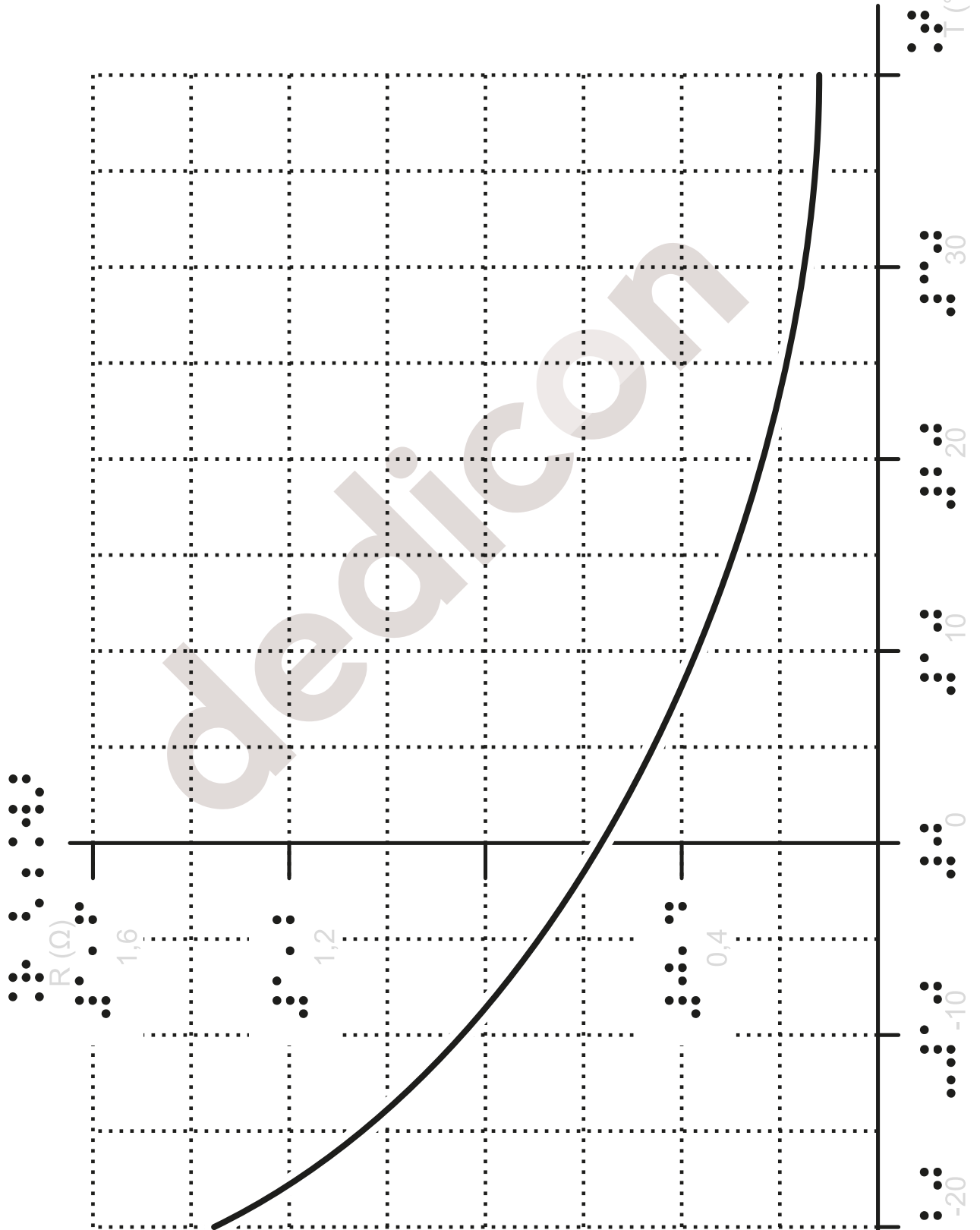

25. Schakeling: diodes
a

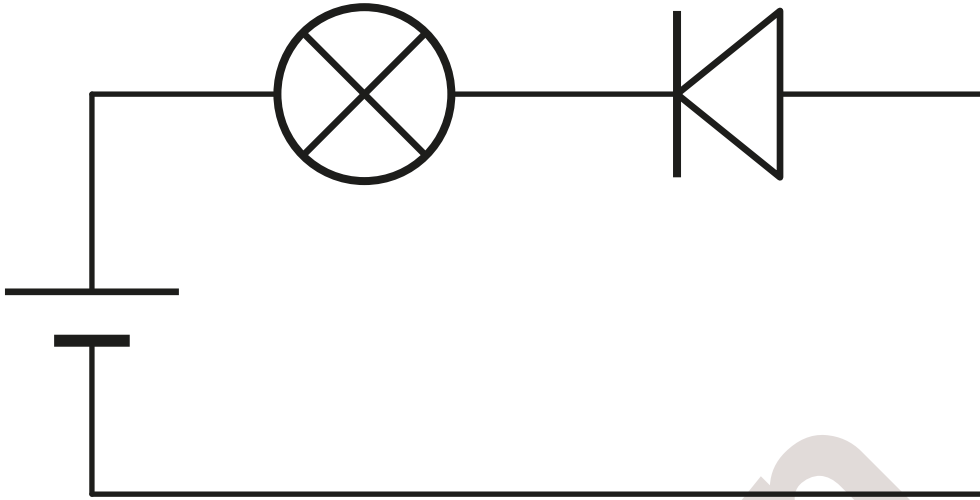

b

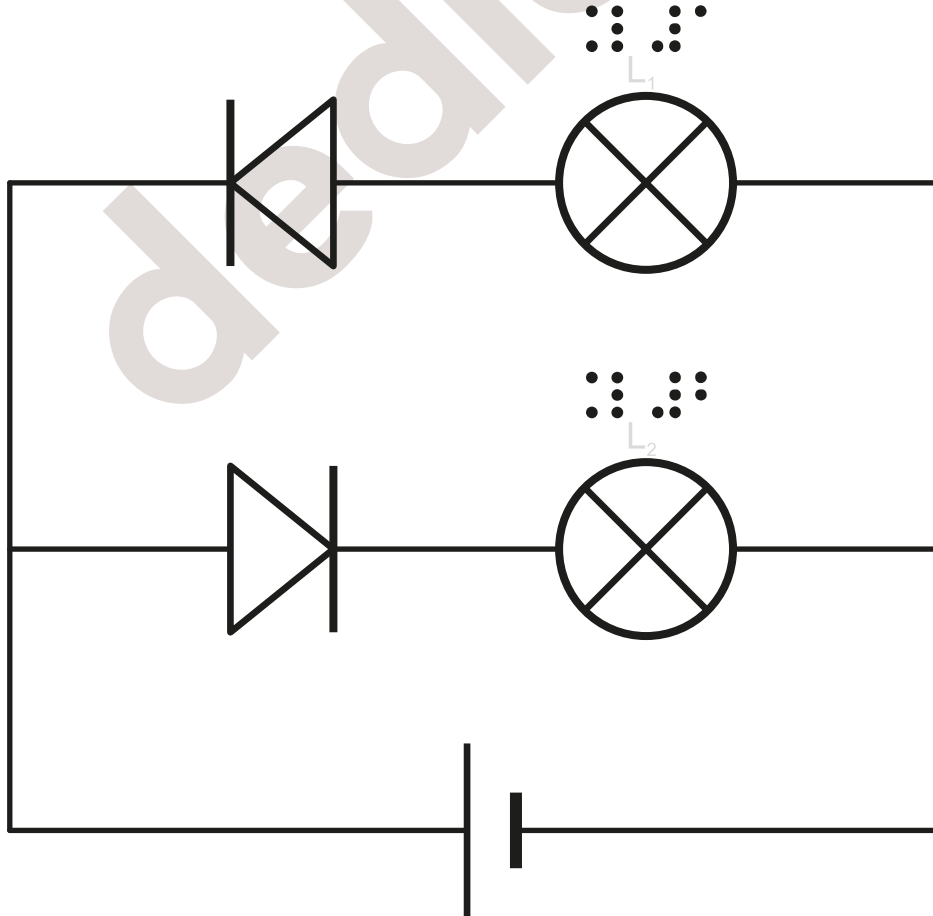

a

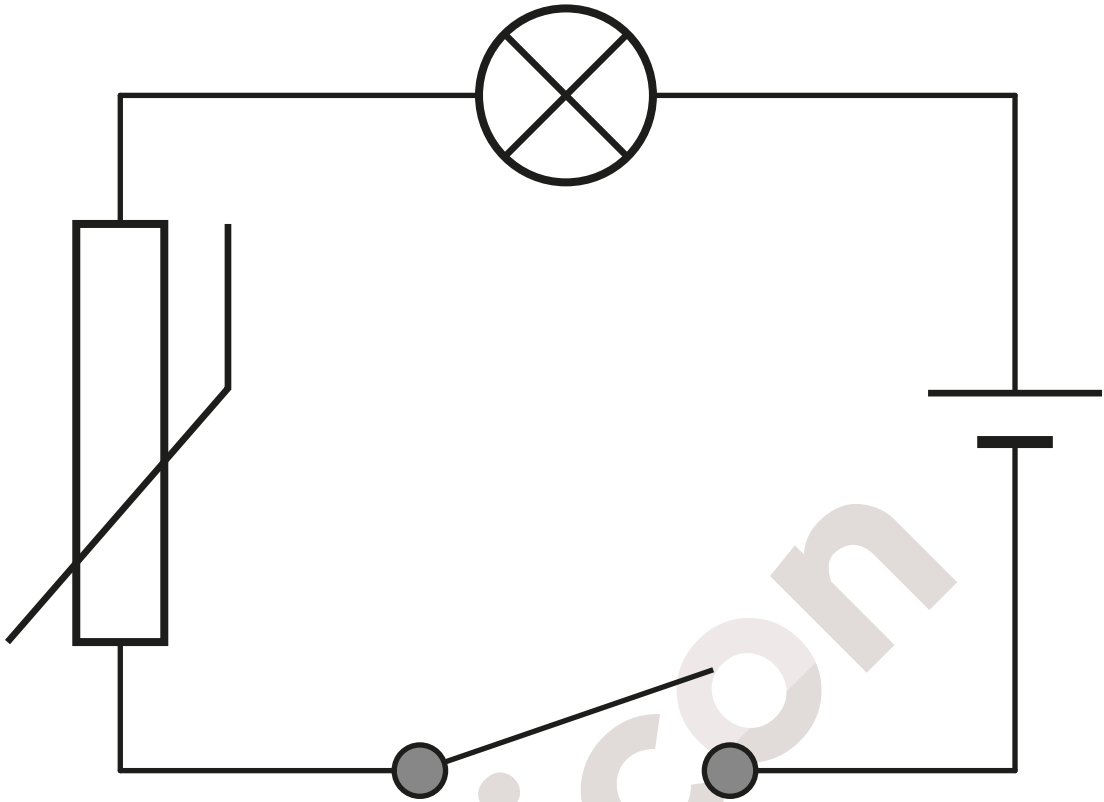

b

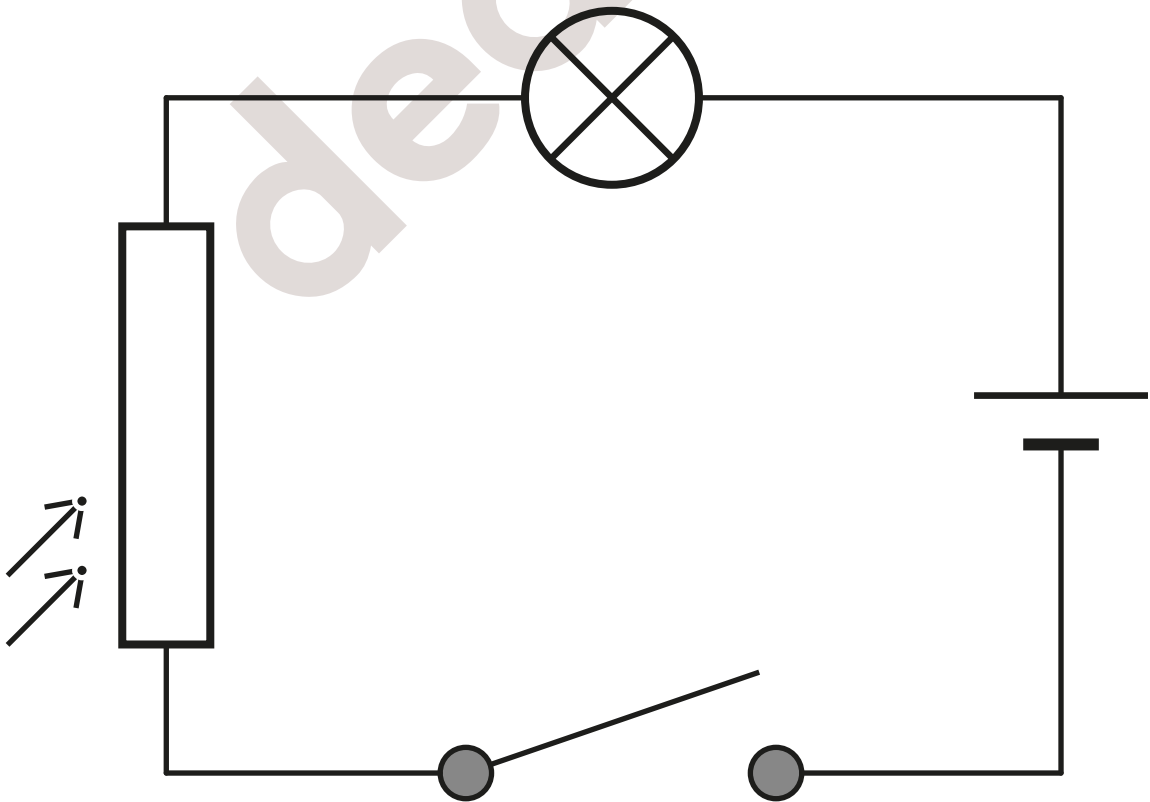

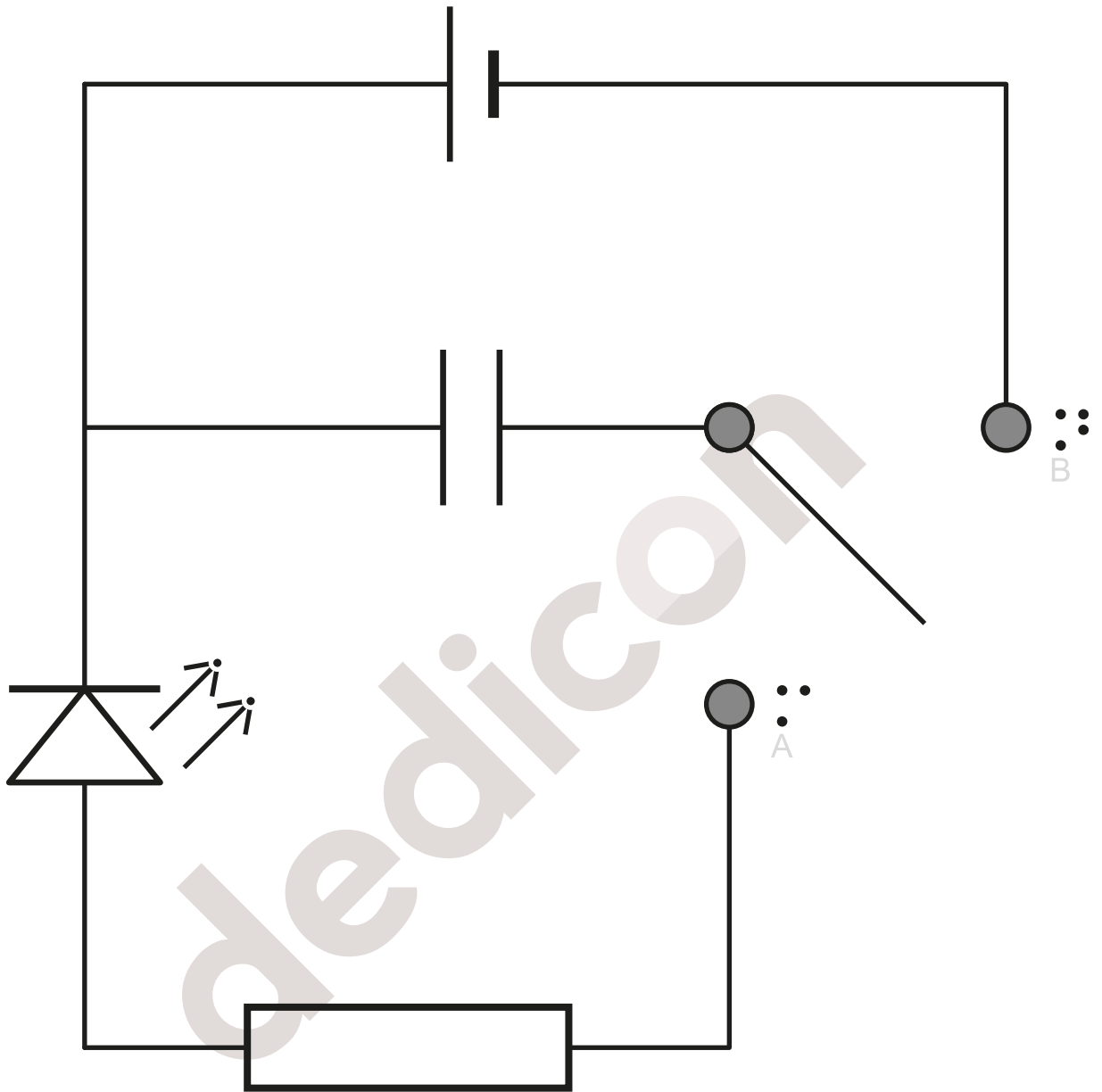

28 a. Koelkast schematisch

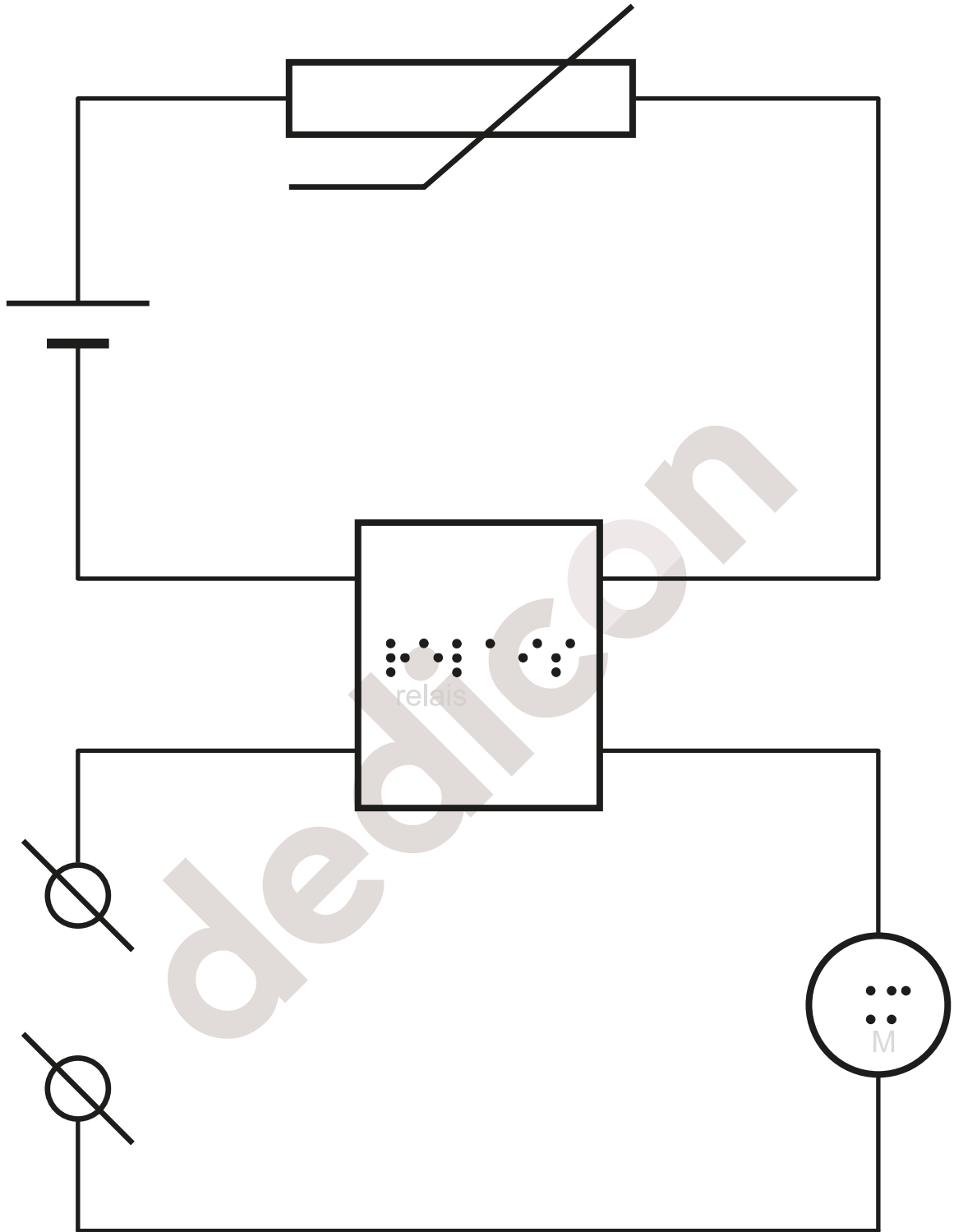



28 b. Koelkast met relais

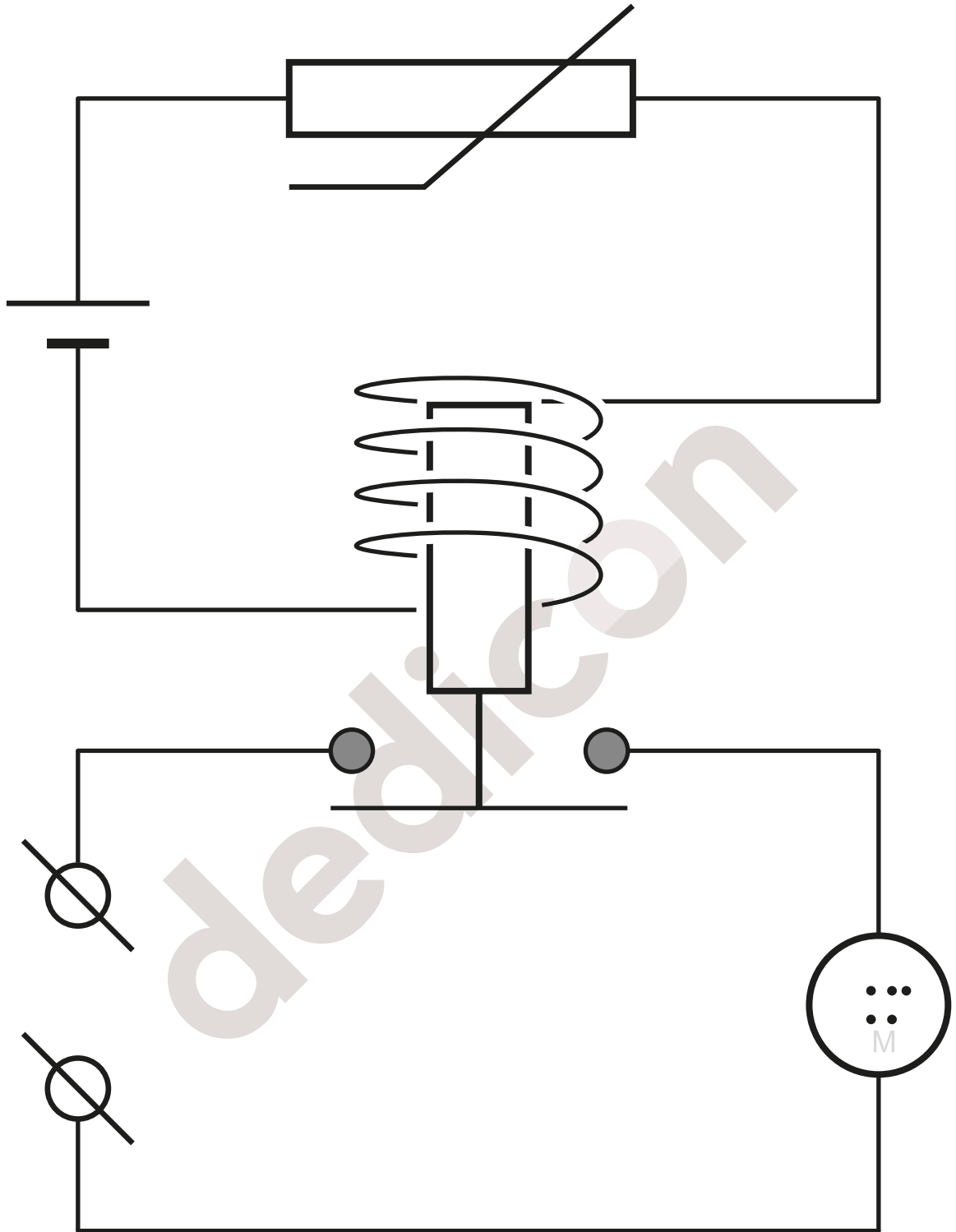

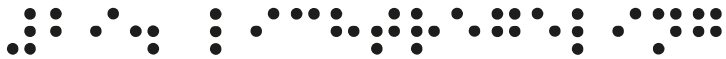

29. Lichtregeling

