

Op de tast...
meten en maten in de middeleeuwen

Op de tast...

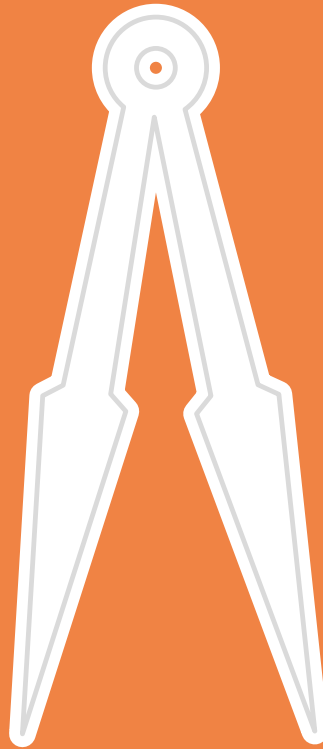

meten en maten
in de middeleeuwen

Bij deze tekeningenband
hoort gelijknamige uitleg
in braille of Edu-tekst

Dedicon, 2020 versie 01

334419_1

Dit is een inzage-exemplaar. Kopiëren en vermenigvuldigen is niet toegestaan.
Deze tekening komt uit een Op de Tast boek, uitsluitend te bestellen door of
voor leerlingen met een visuele beperking op <https://educatief.dedicon.nl>

© dedicon

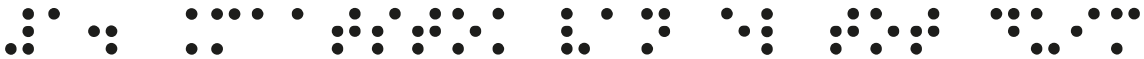

1. Maatstok van el tot duim



pouce (duim)



palme (palm)

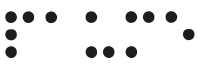

paume



empan



pied (voet)



coudée (el)

2.a De arm als basis

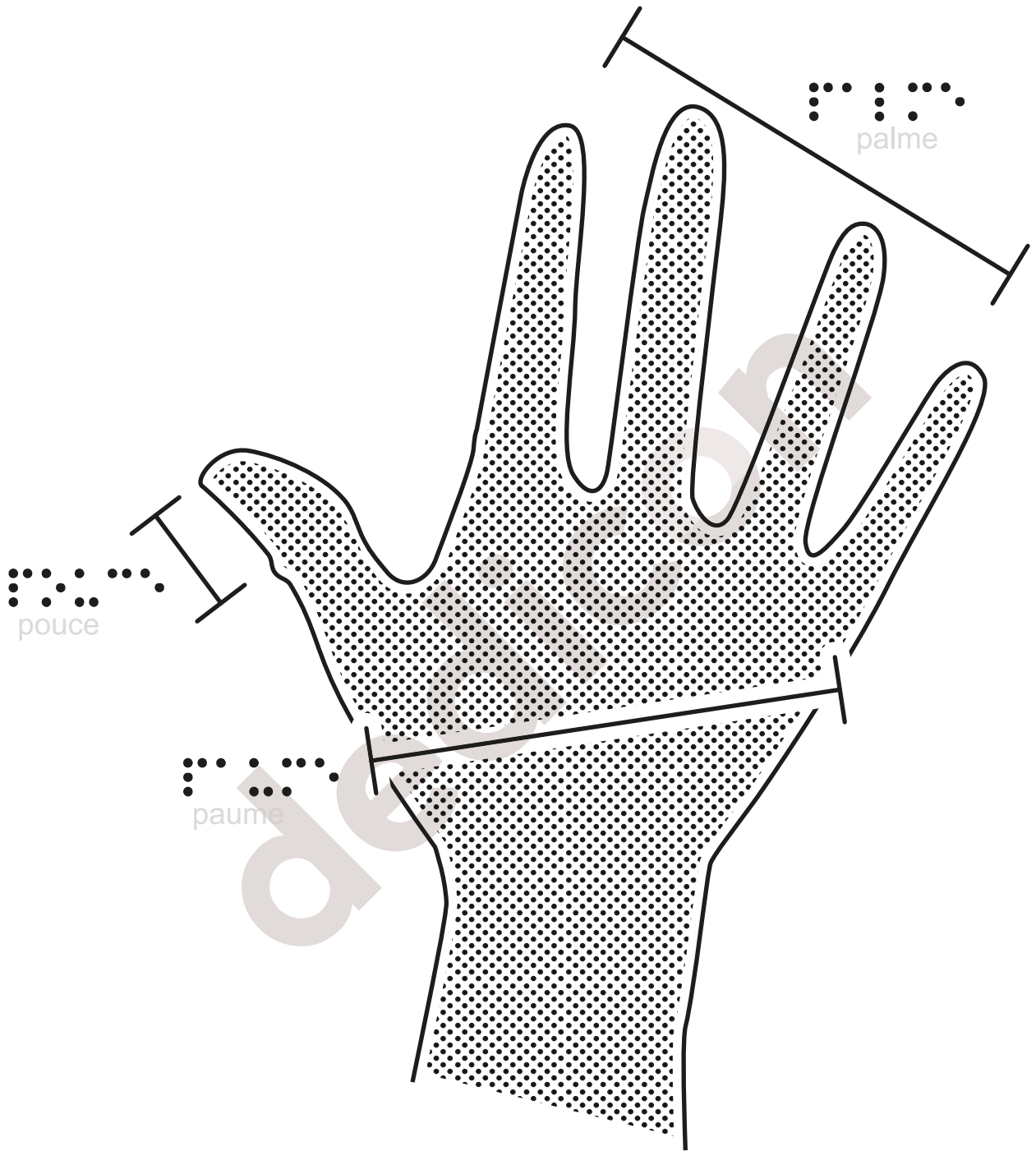

2.b De arm als basis

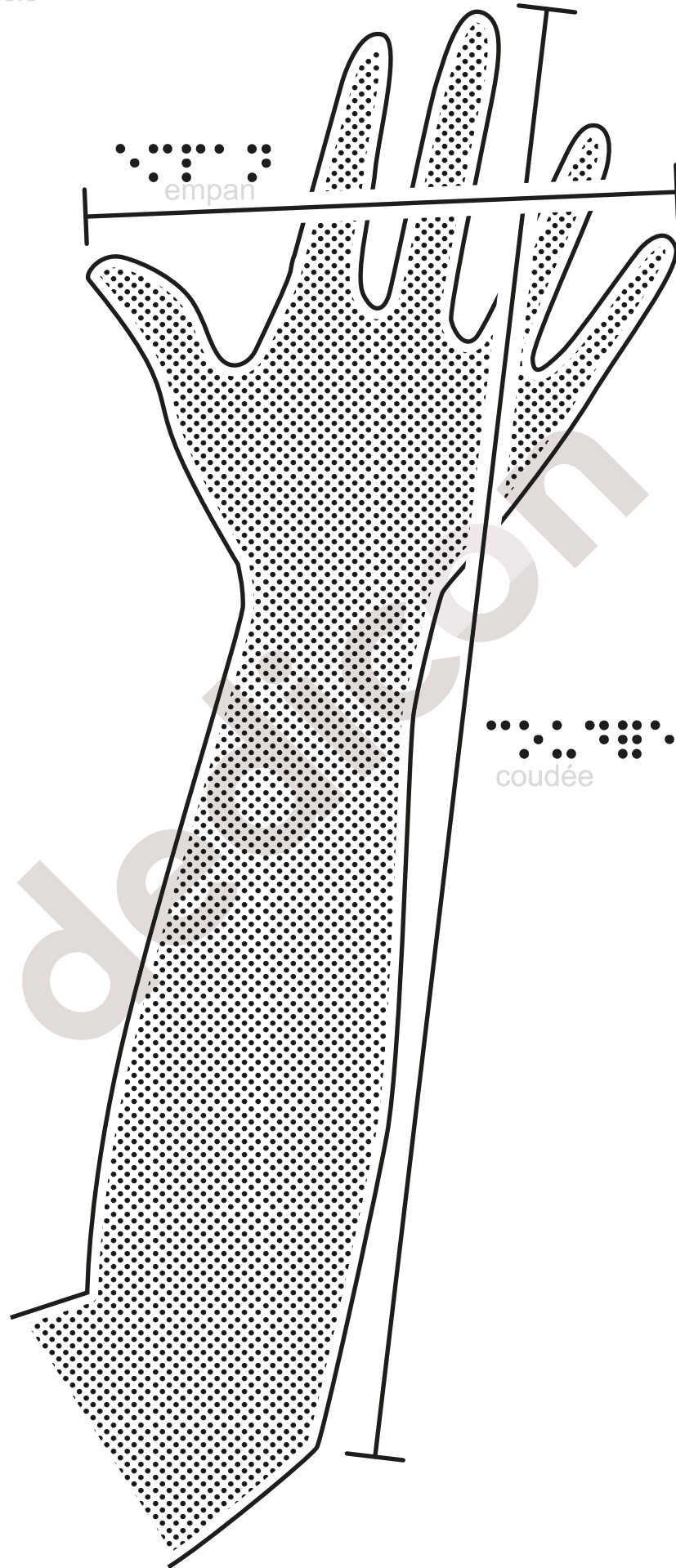

Dit is een inzage-exemplaar. Kopiëren en vermenigvuldigen is niet toegestaan.
Deze tekening komt uit een Op de Tast boek, uitsluitend te bestellen door of
voor leerlingen met een visuele beperking op <https://educatief.dedicon.nl>

© dedicon

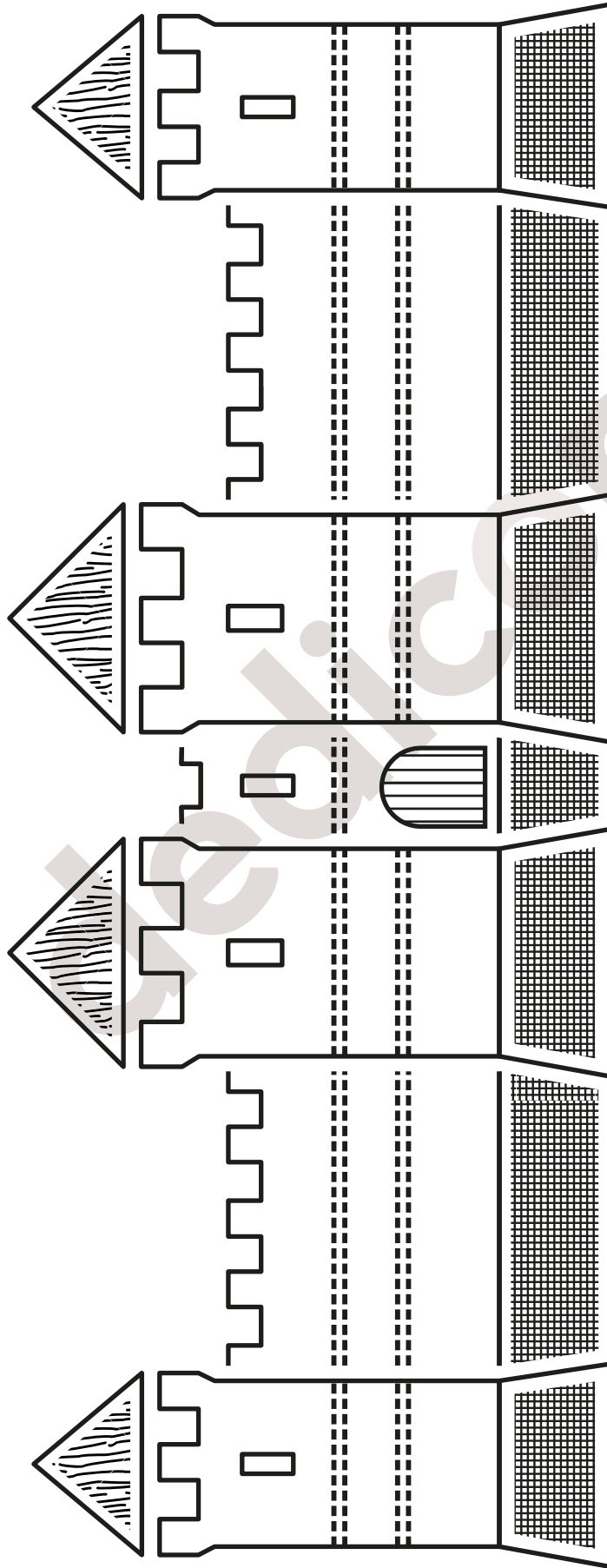

Dit is een inzage-exemplaar. Kopiëren en vermenigvuldigen is niet toegestaan.
Deze tekening komt uit een Op de Tast boek, uitsluitend te bestellen door of
voor leerlingen met een visuele beperking op <https://educatief.dedicon.nl>

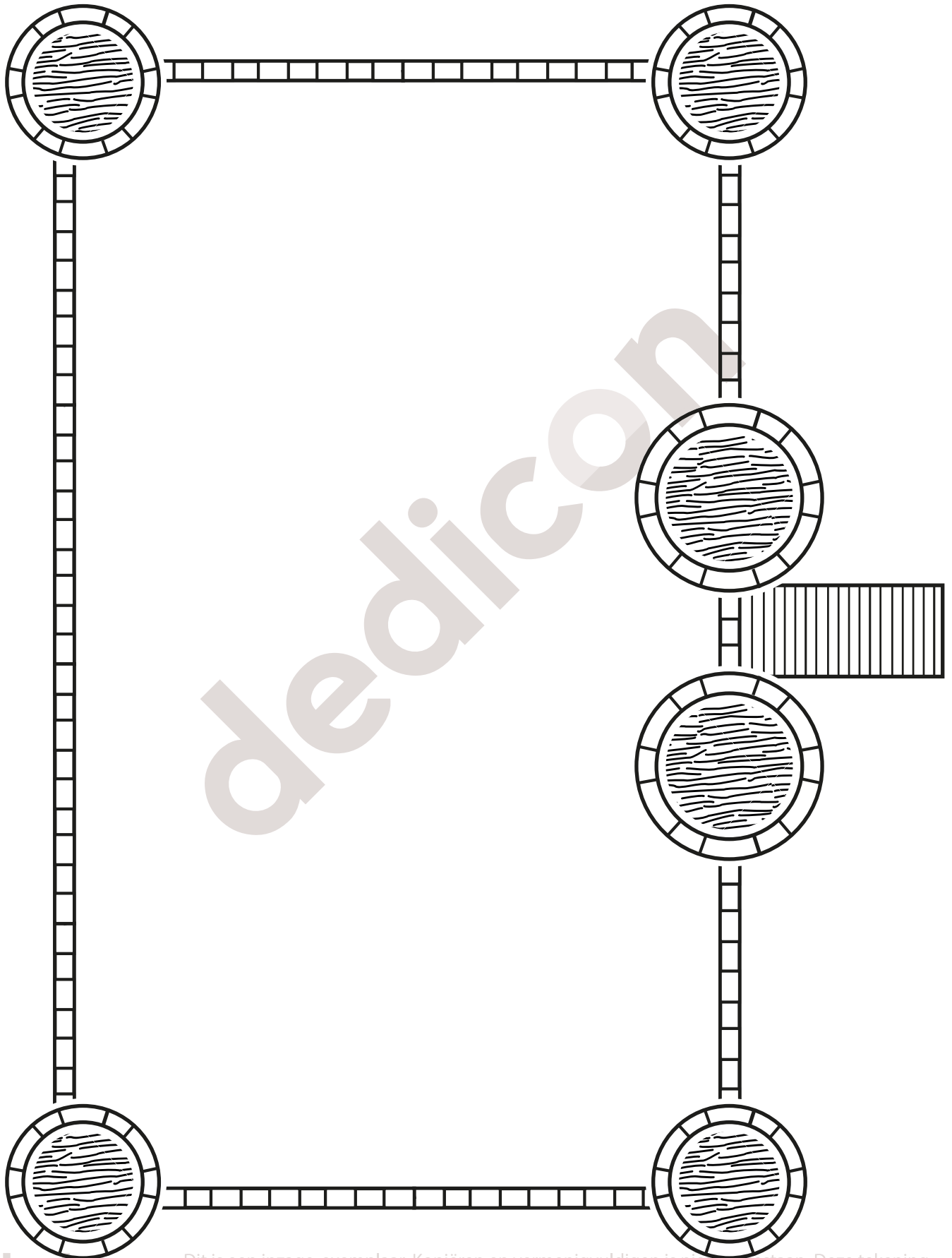



5. Toren van het kasteel

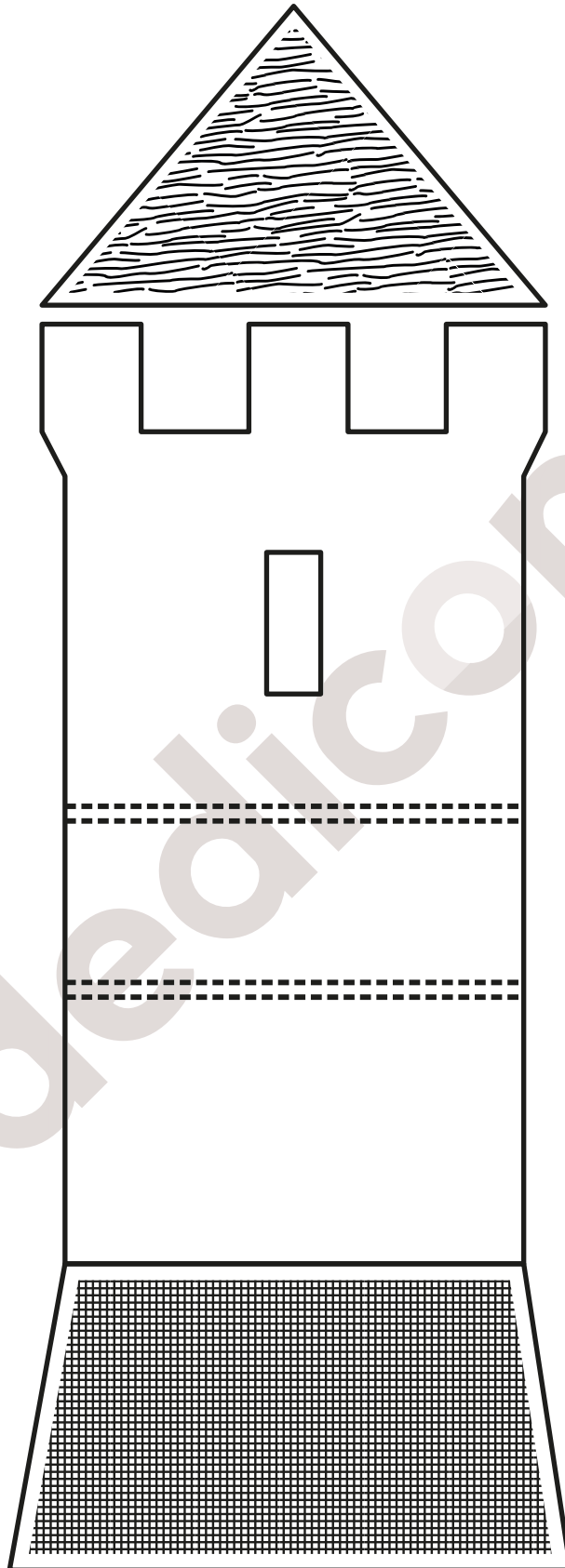

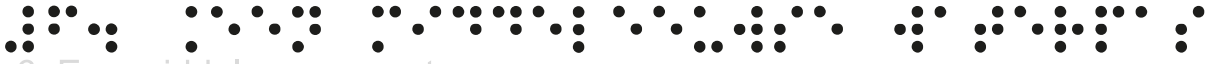

6. Een middeleeuwse waterpas

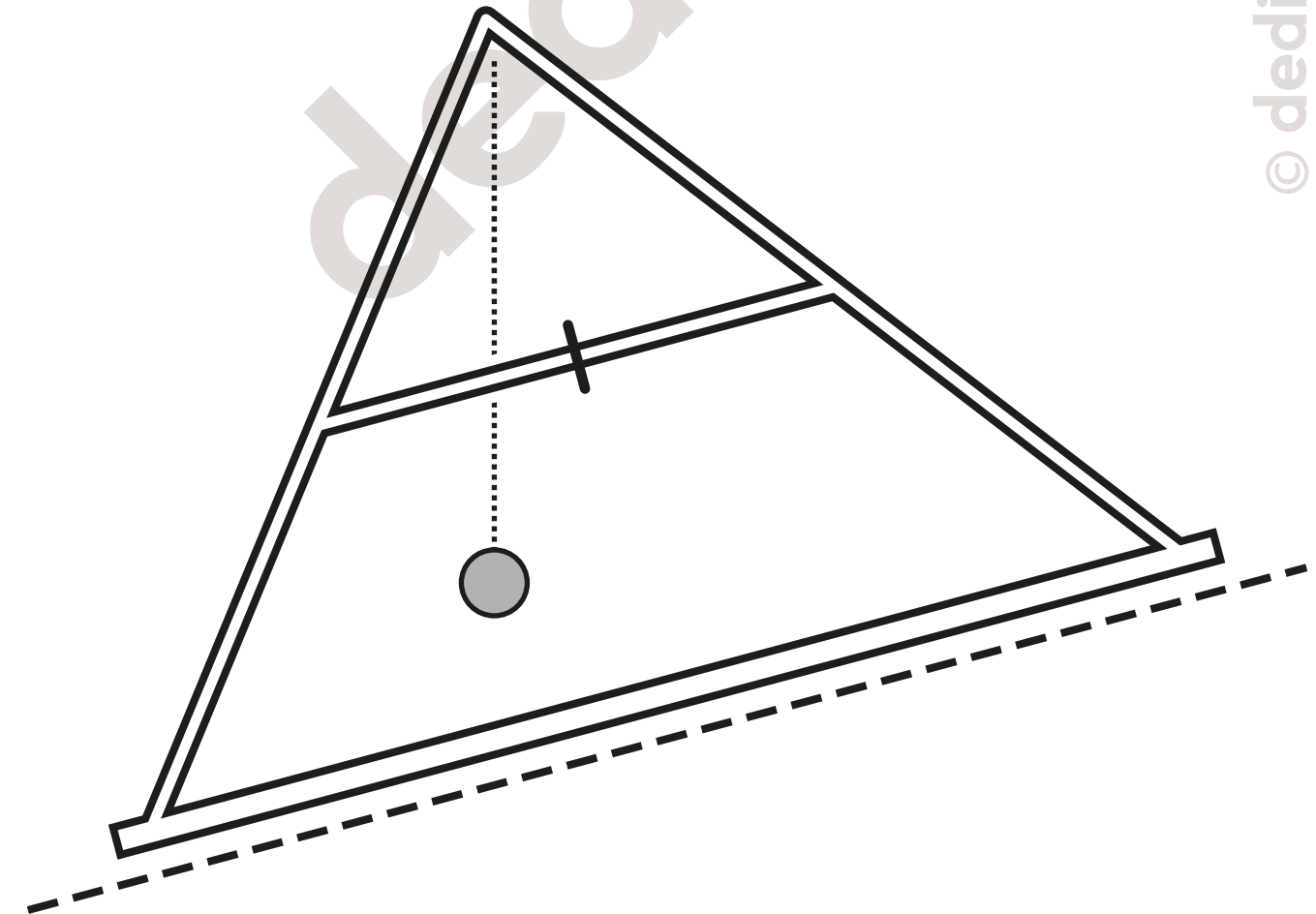
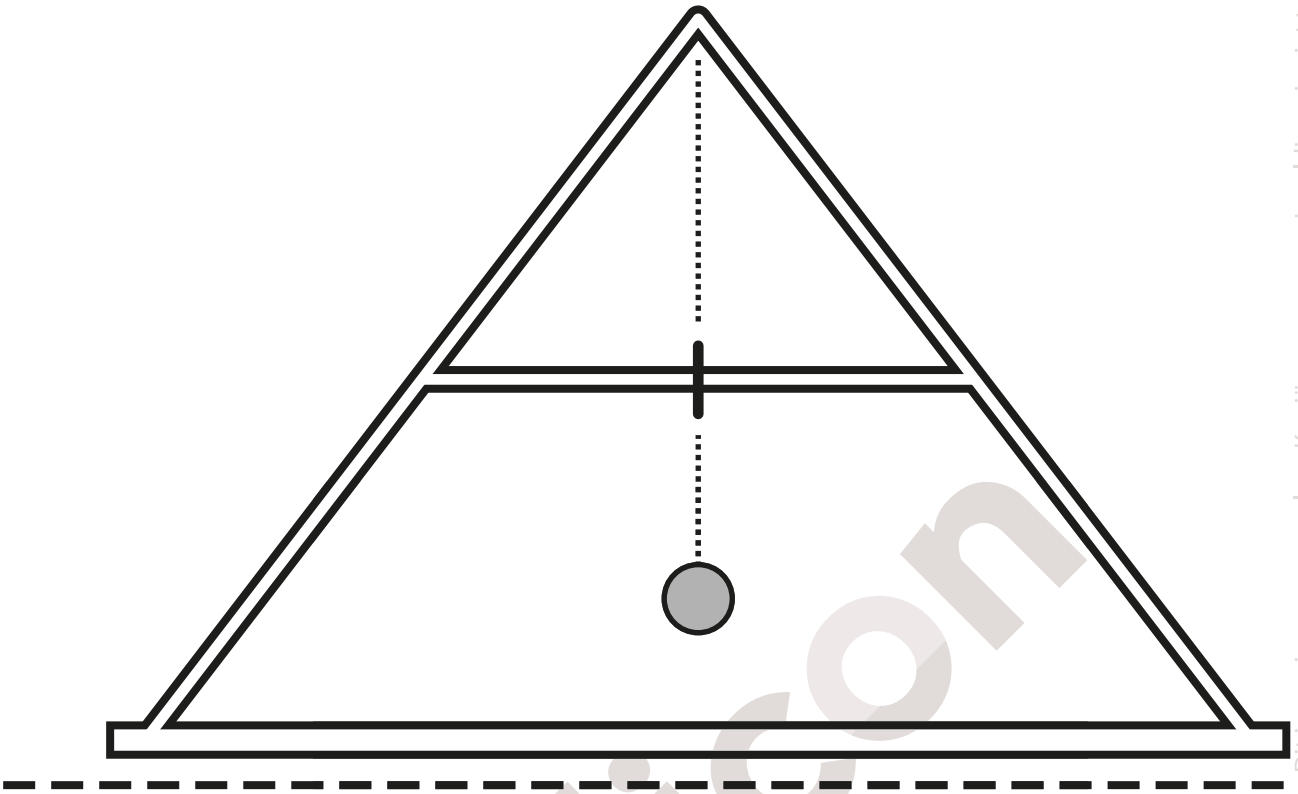

Dit is een inzage-exemplaar. Kopiëren en vermenigvuldigen is niet toegestaan. Deze tekening komt uit een Op de Tast boek, uitsluitend te bestellen door of voor leerlingen met een visuele beperking op <https://educatief.dedicon.nl>

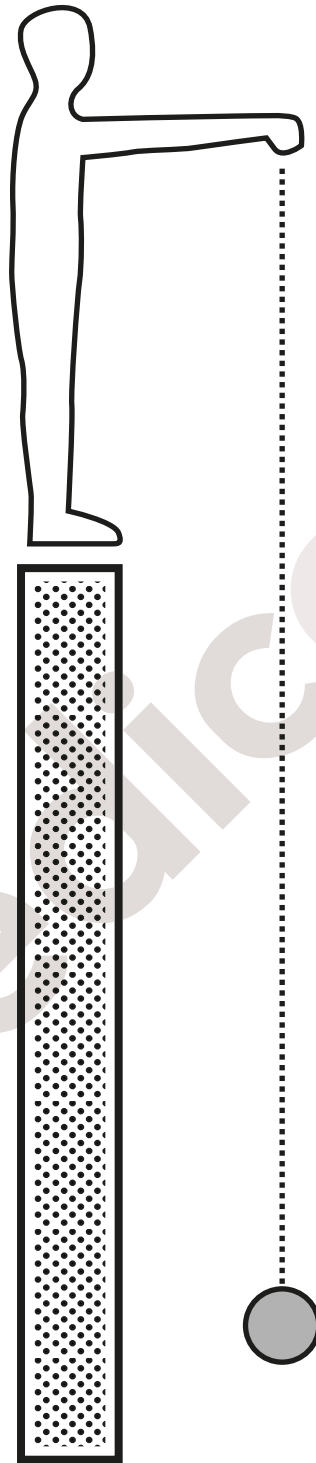

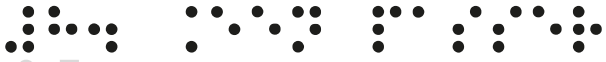

8. Een passer

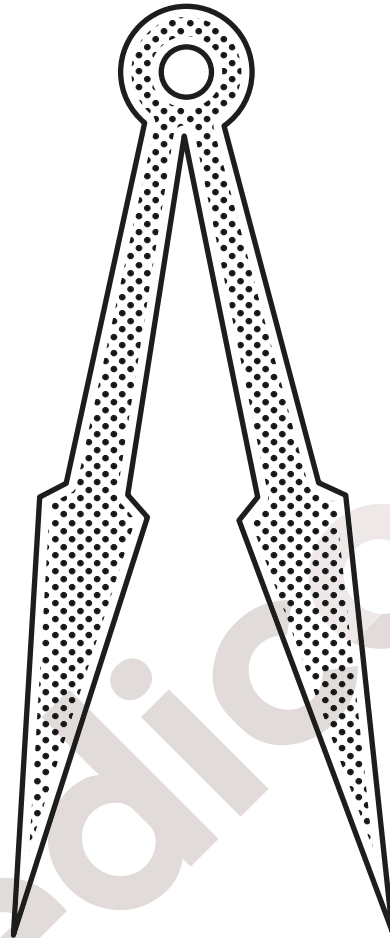

dedicon



9. Overlappende cirkels

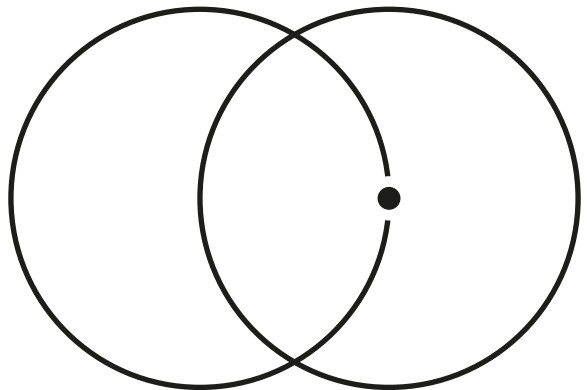
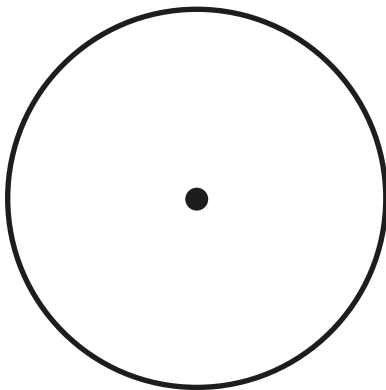
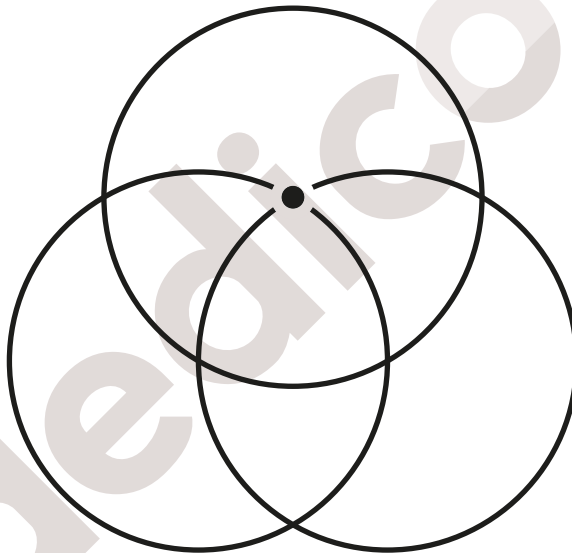
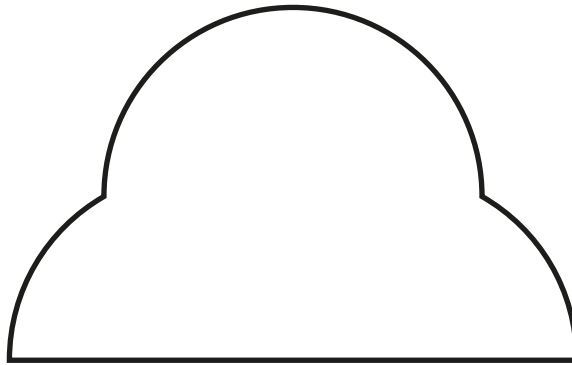



10. Gotisch raam

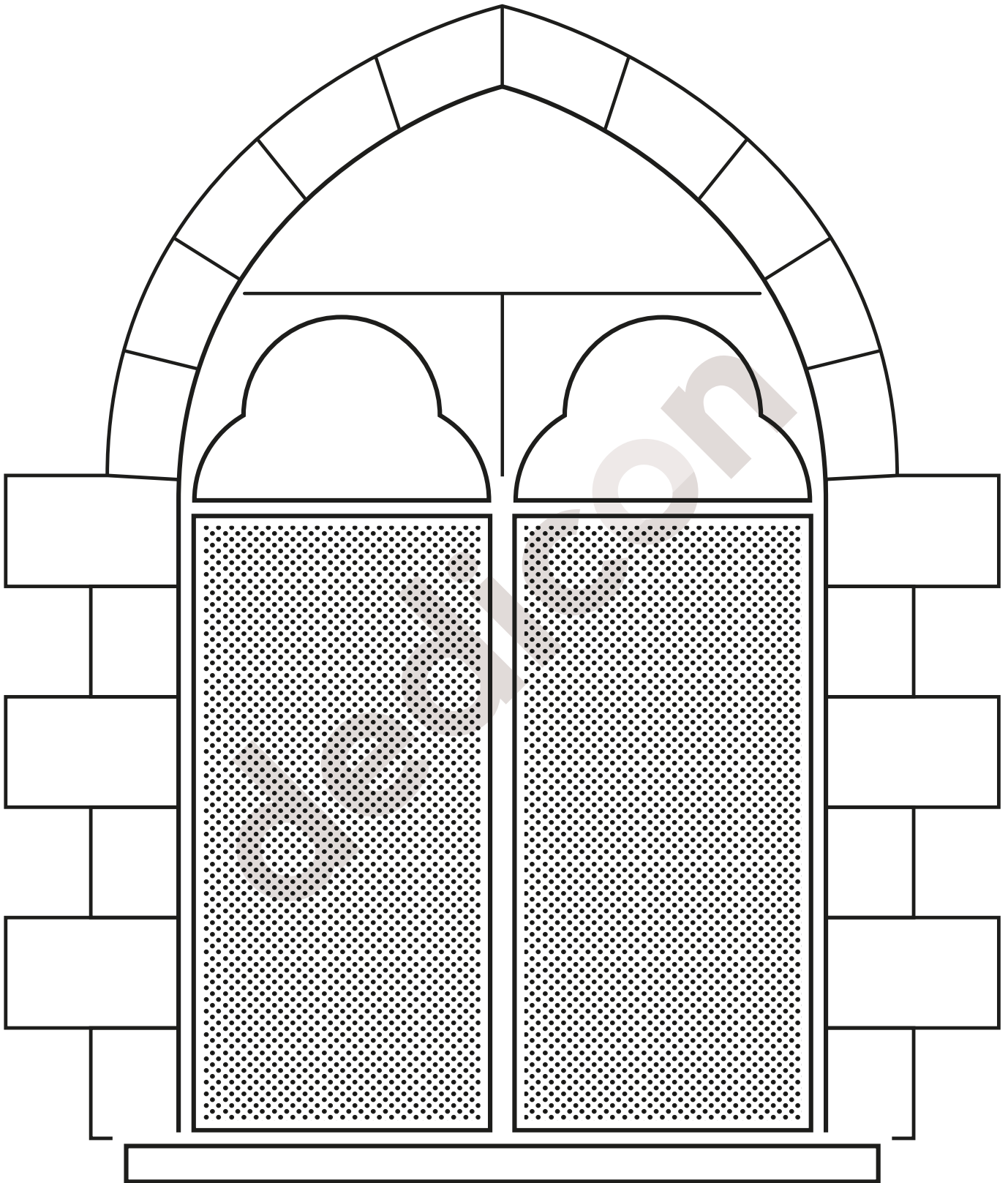



11. Een 13-knopen touw

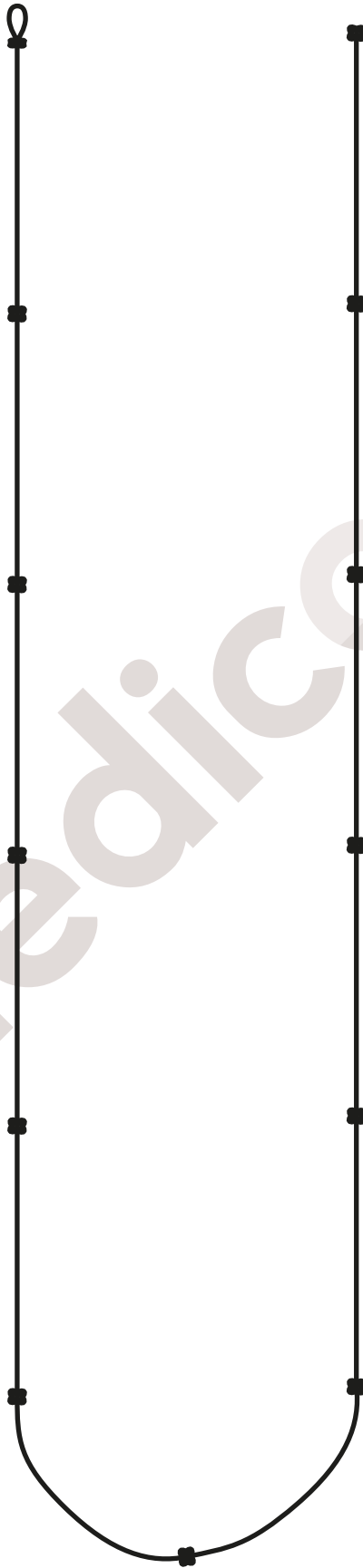



12. Een driehoek met een 13-knopentouw

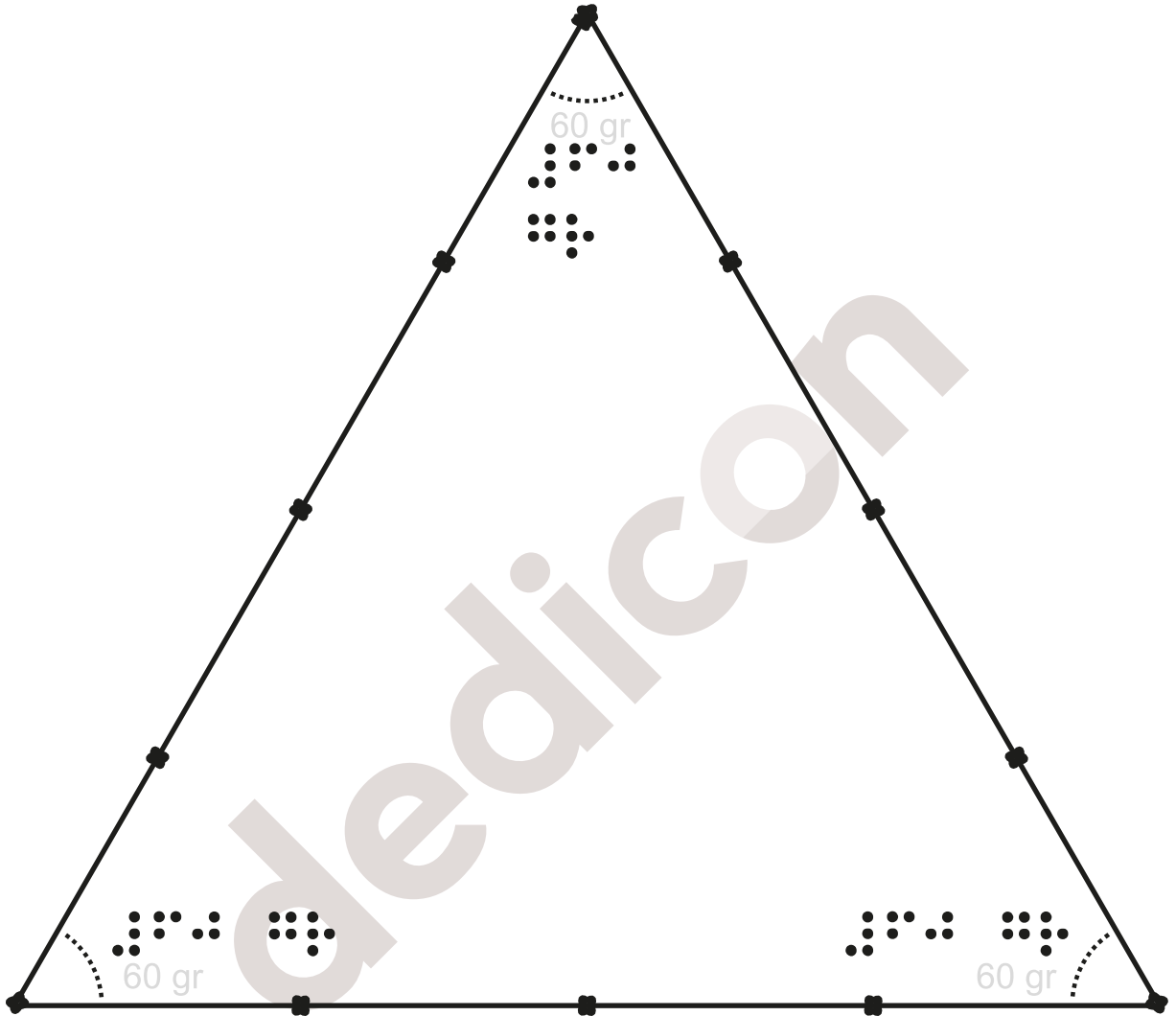



13. Driehoeken met een 13-knopentouw

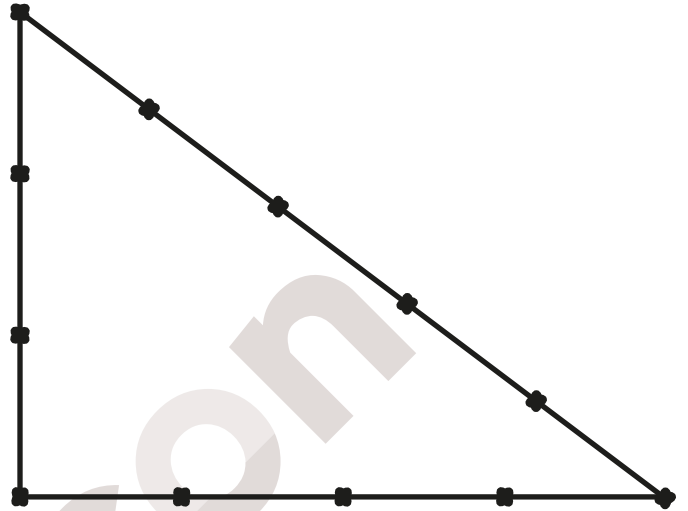
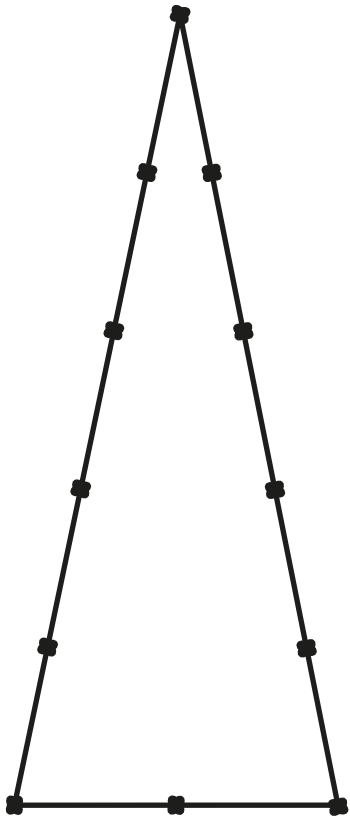

dedicon

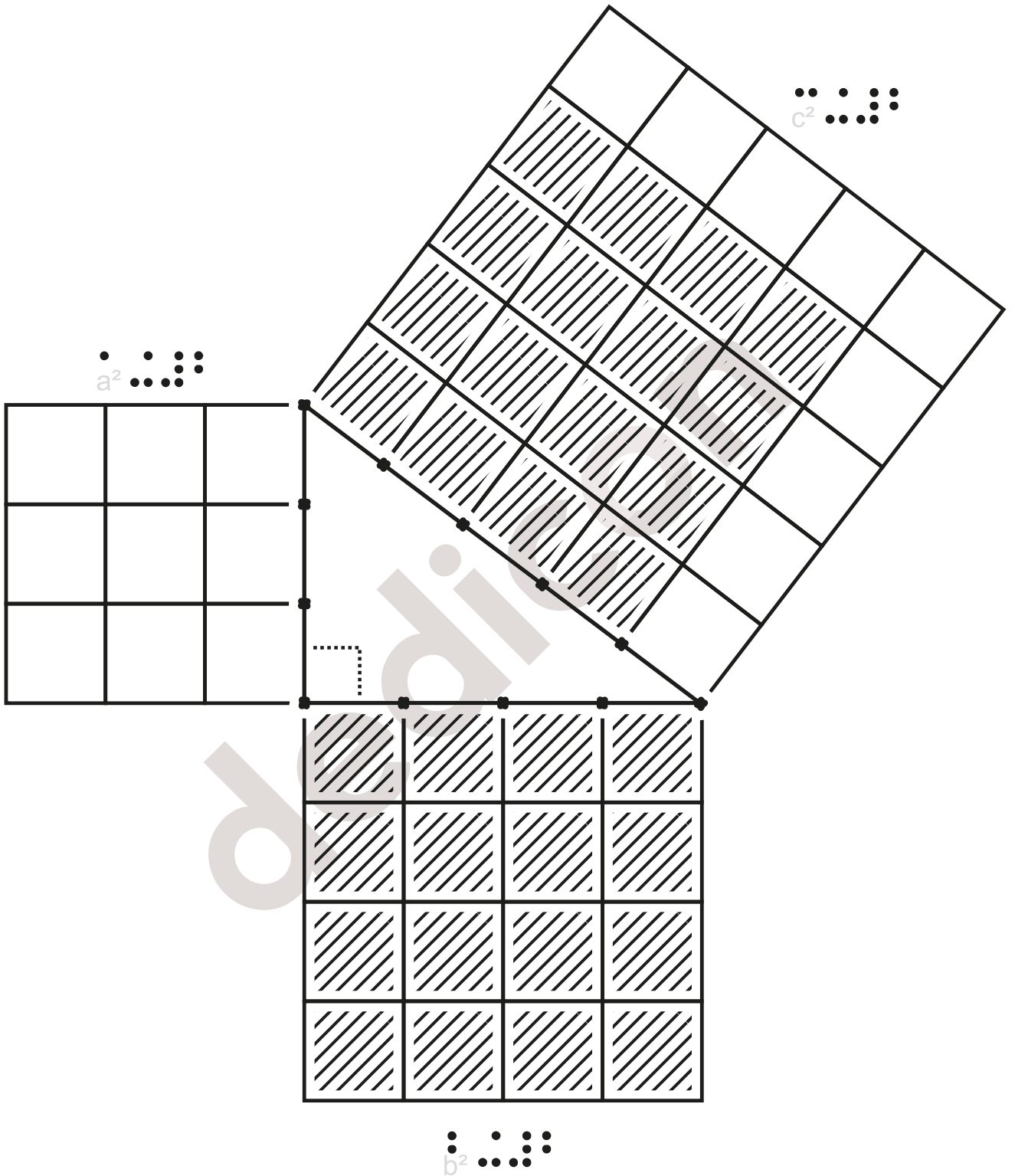



15. Een dak van driehoeken

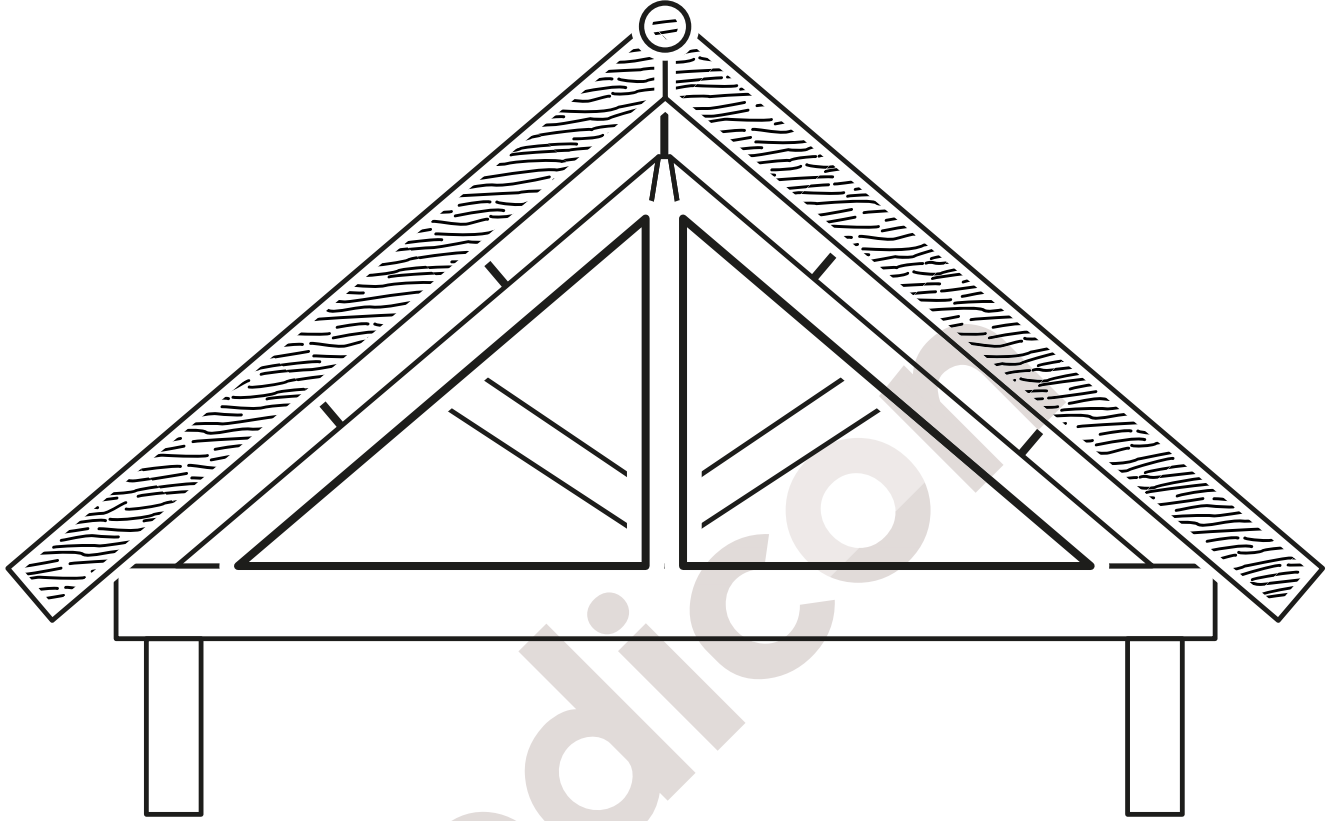



16. Winkelhaak

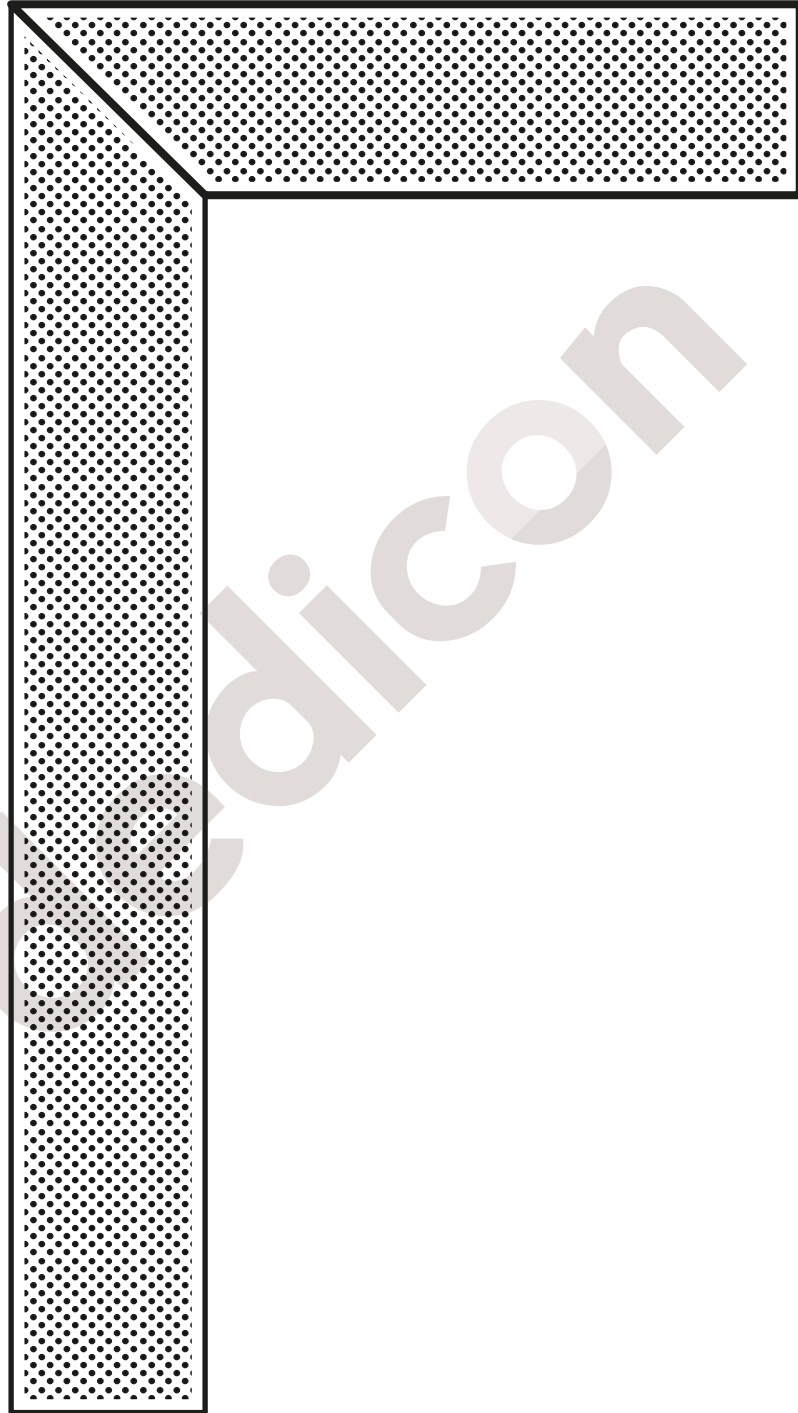



17. Vierhoeken met een 13-knopentouw

