

Op de tast...  
symmetrie

Op de tast



symmetrie

Bij deze tekeningenband  
hoort gelijknamige uitleg  
in braille of Edu-tekst

Dedicon, 2022 versie 01



Dit is een inzage-exemplaar. Kopiëren en vermenigvuldigen is niet toegestaan.  
Deze tekening komt uit een Op de Tast boek, uitsluitend te bestellen door of  
voor leerlingen met een visuele beperking op <https://educatief.dedicon.nl>

© dedicon

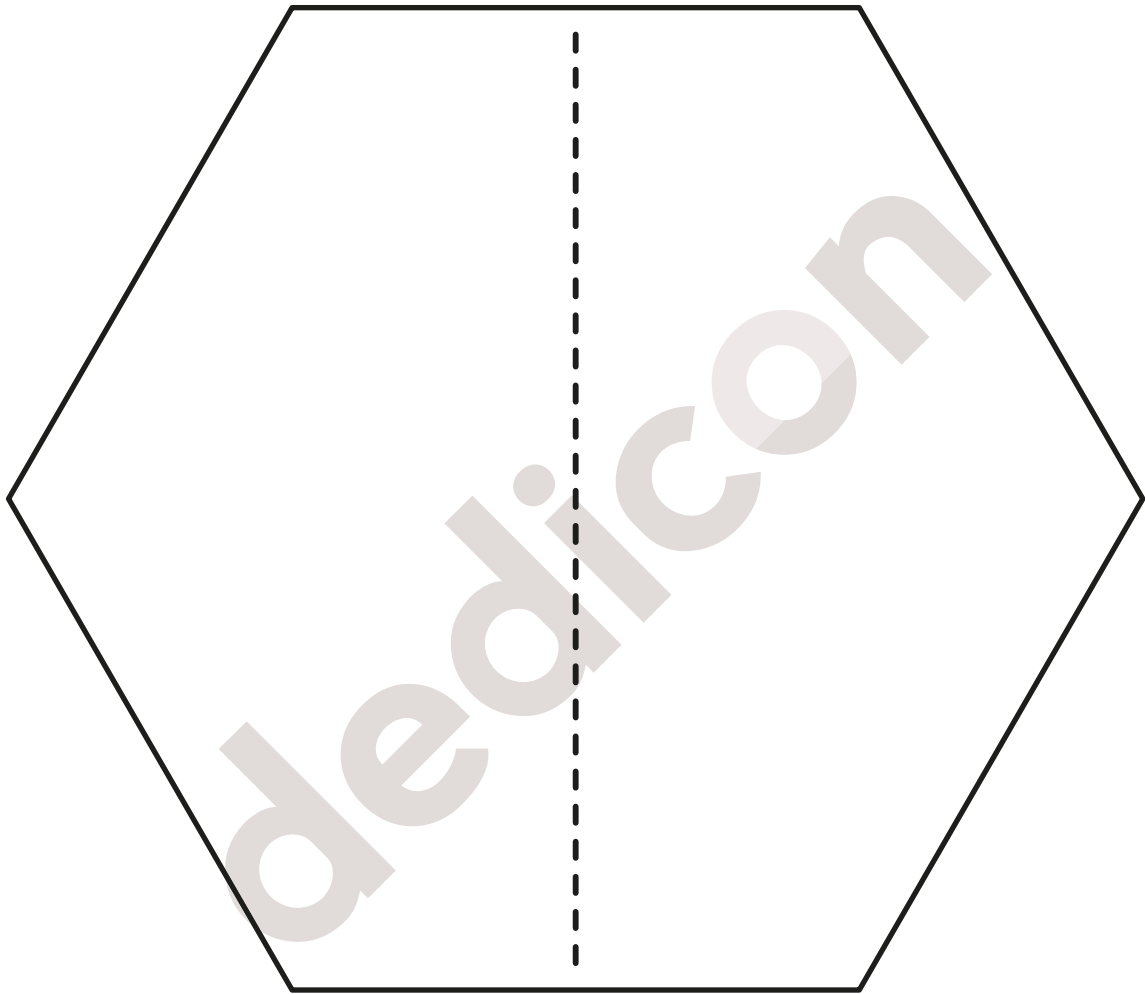

2.  
A

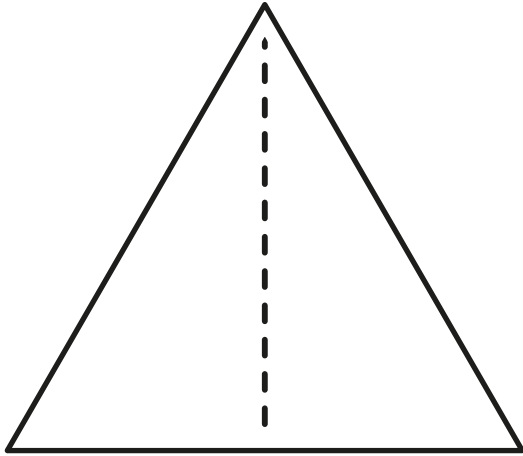

B

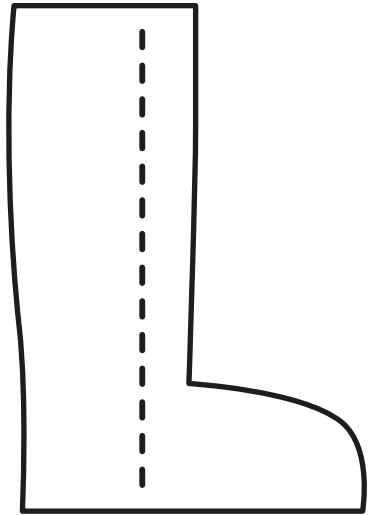

C

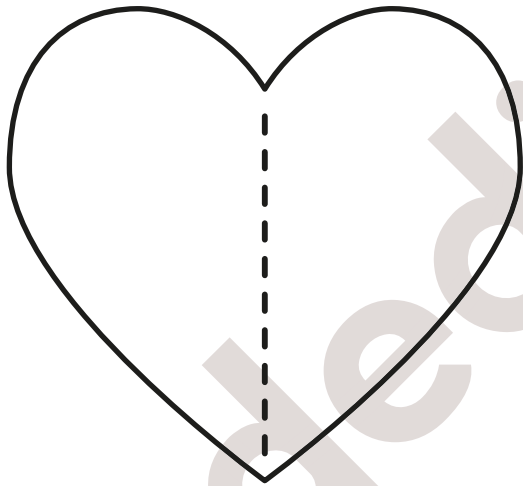

D

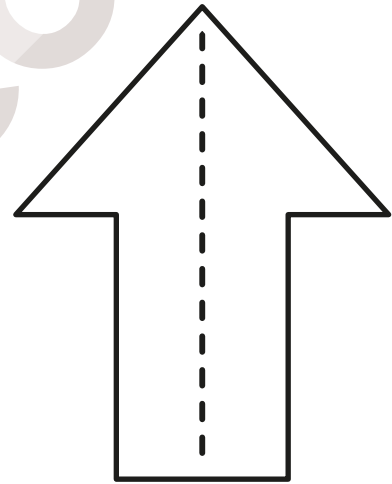

E

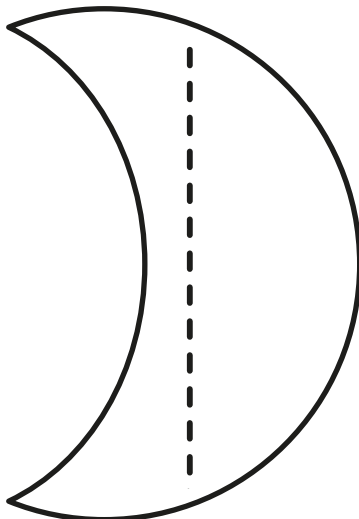

F

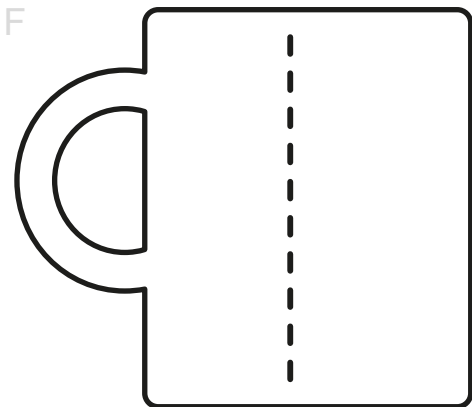

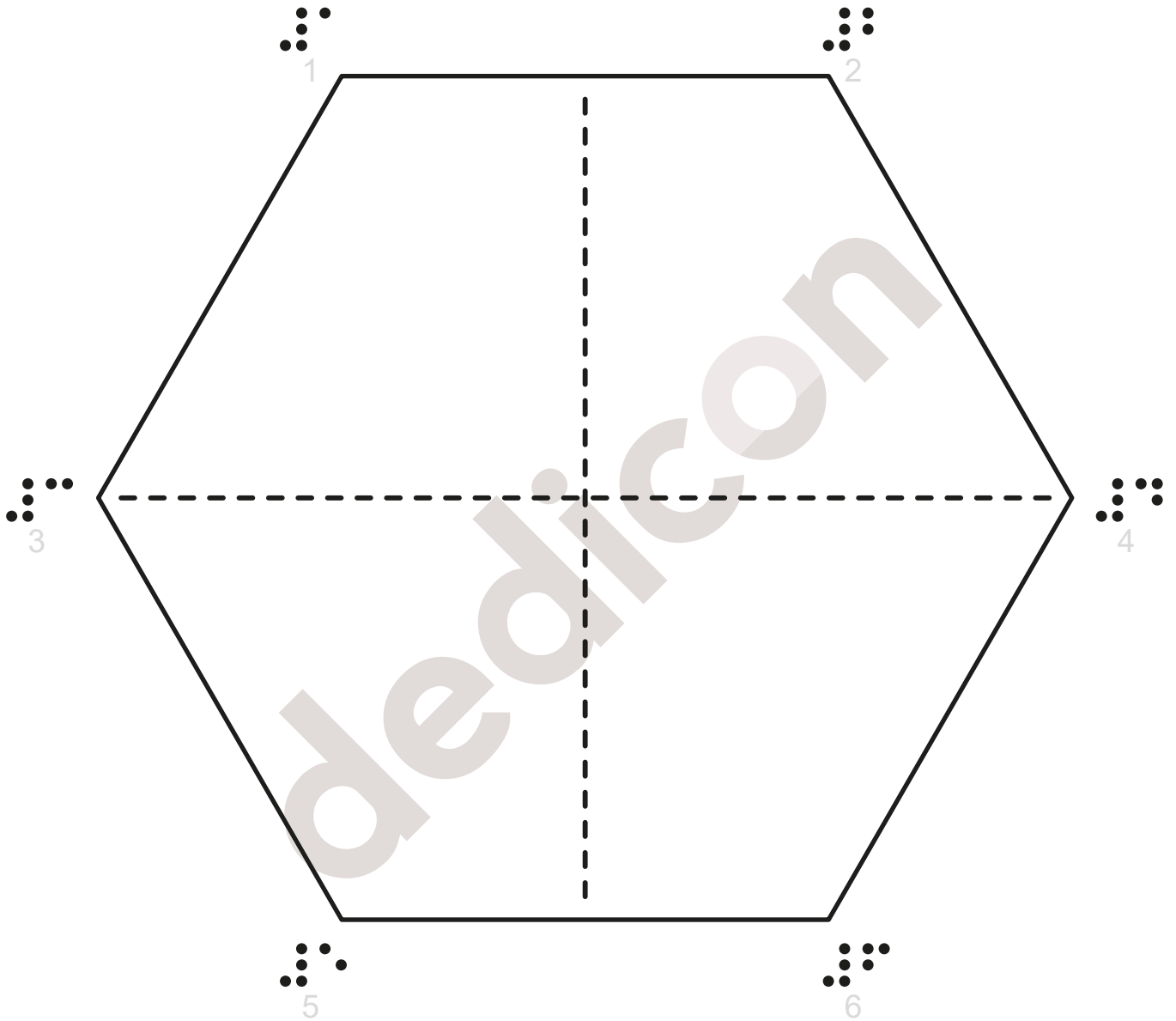

4.  
A

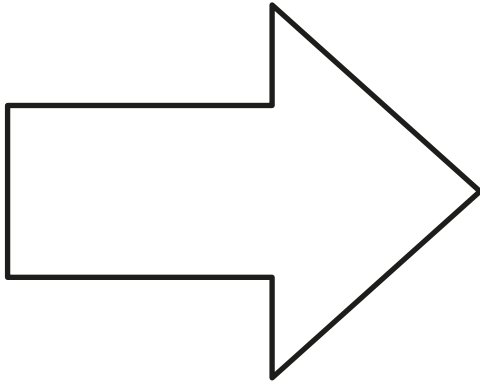

B

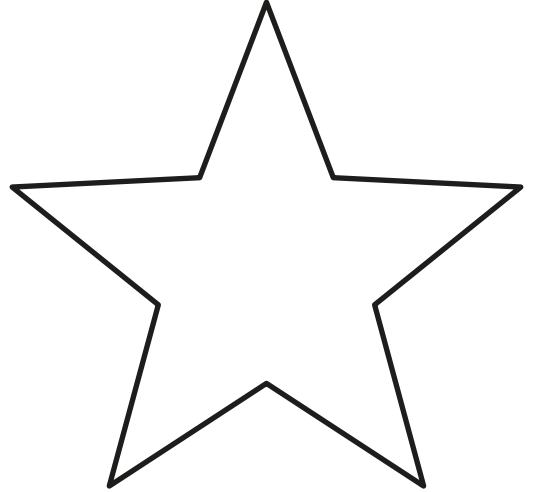

C

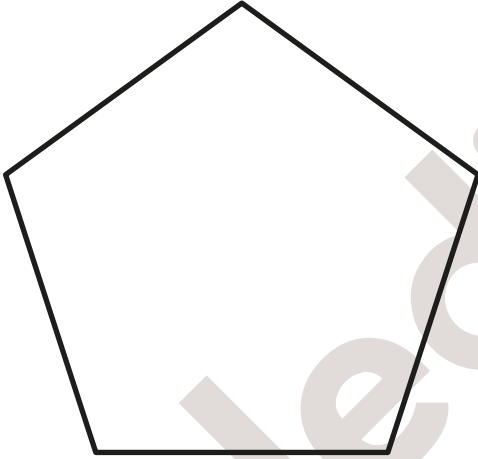

D

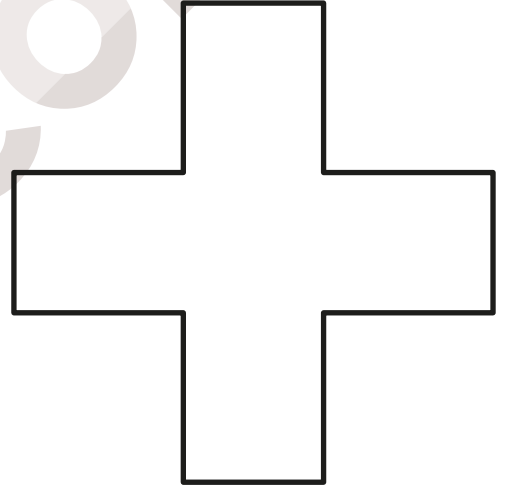

E

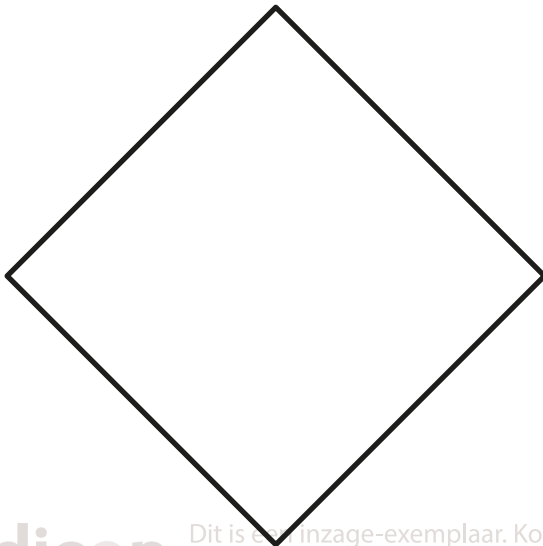

F

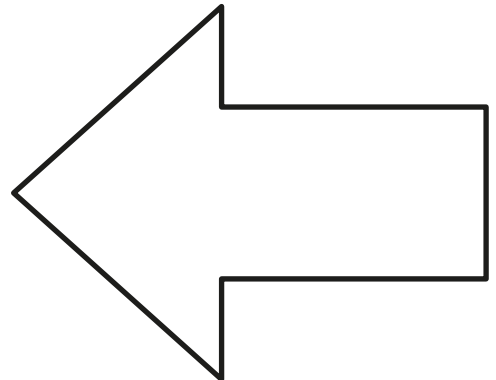

5.  
A

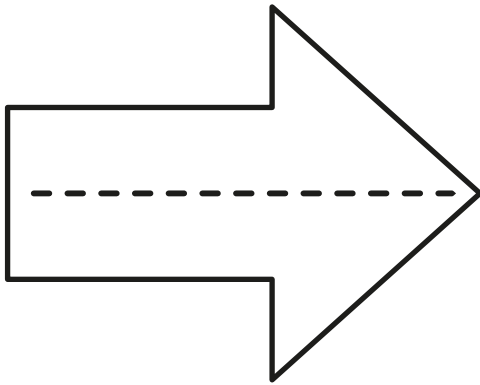

B

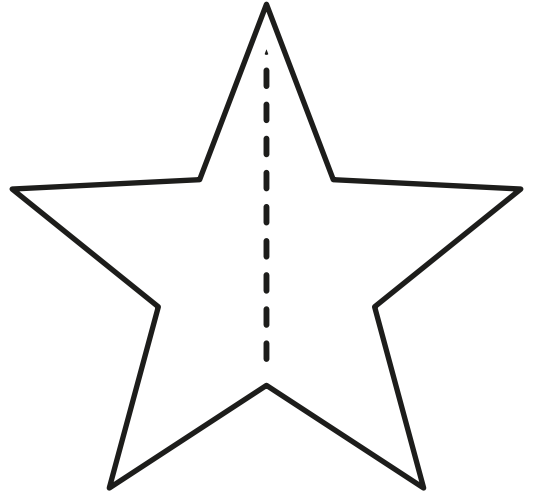

C

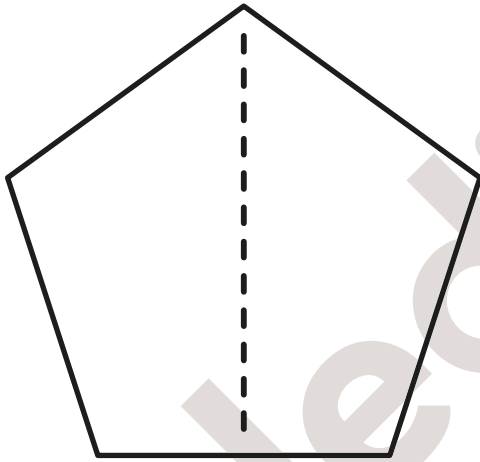

D

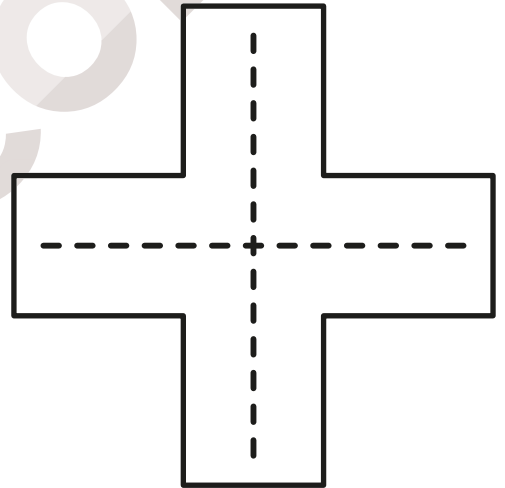

E

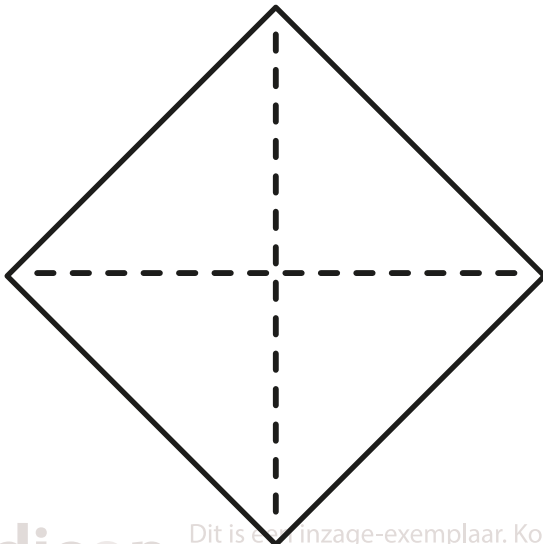

F

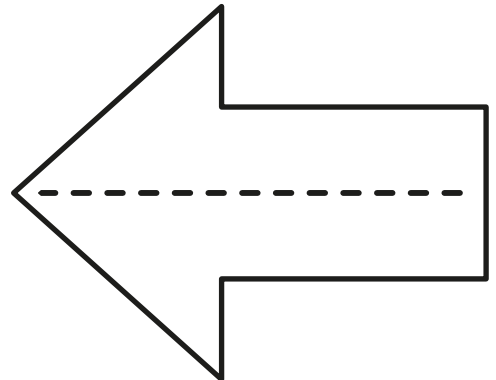



6.



A

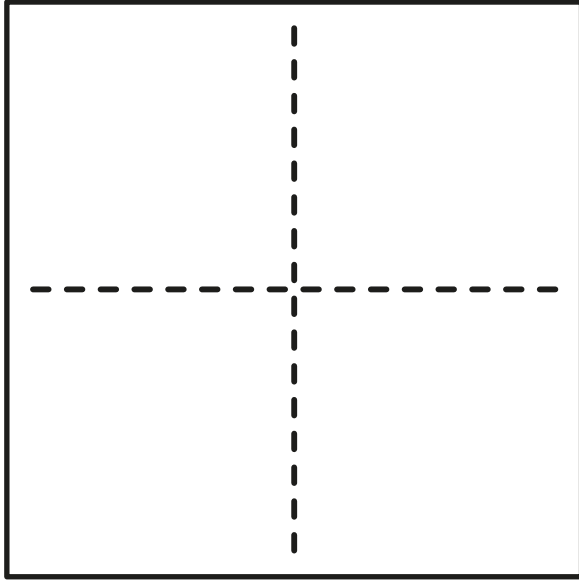

B

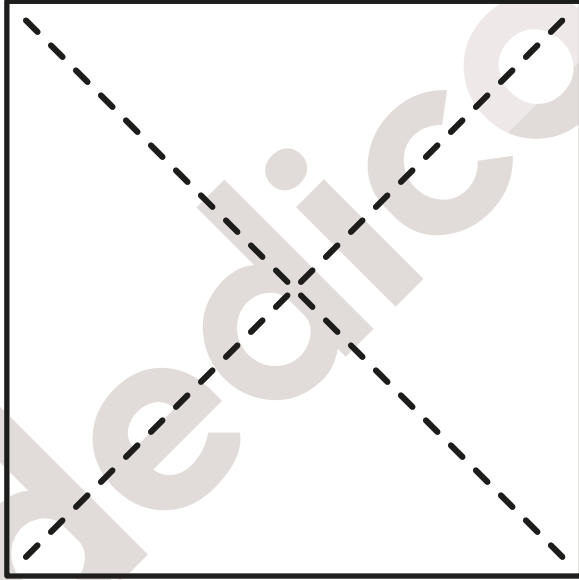

C

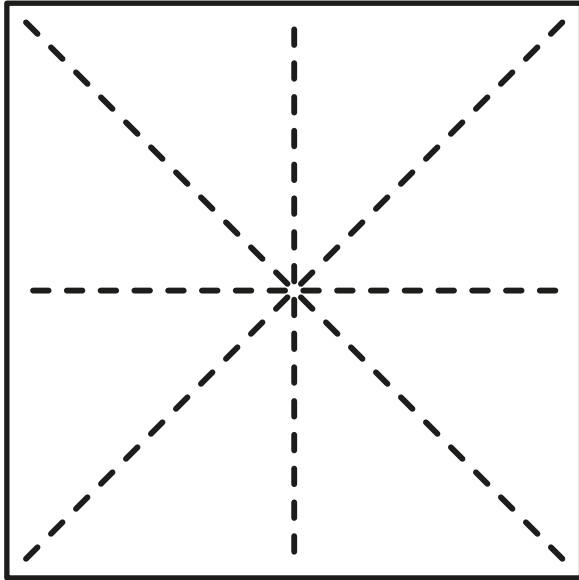

7.  
A

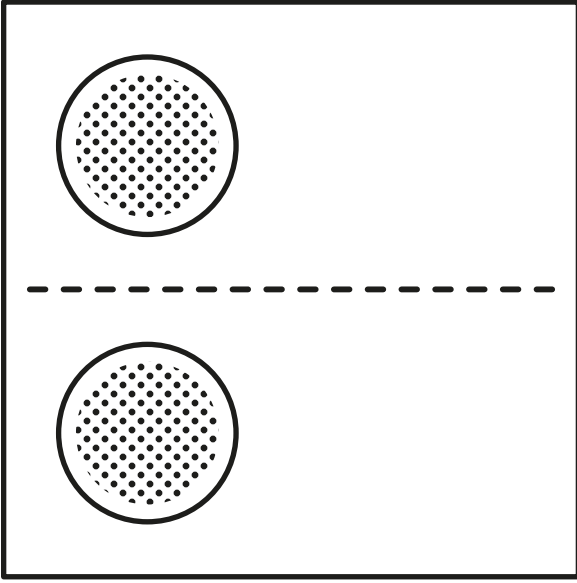

B

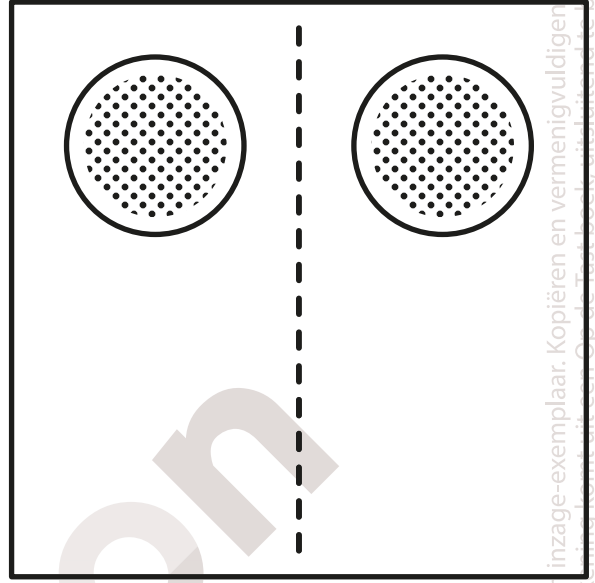

C

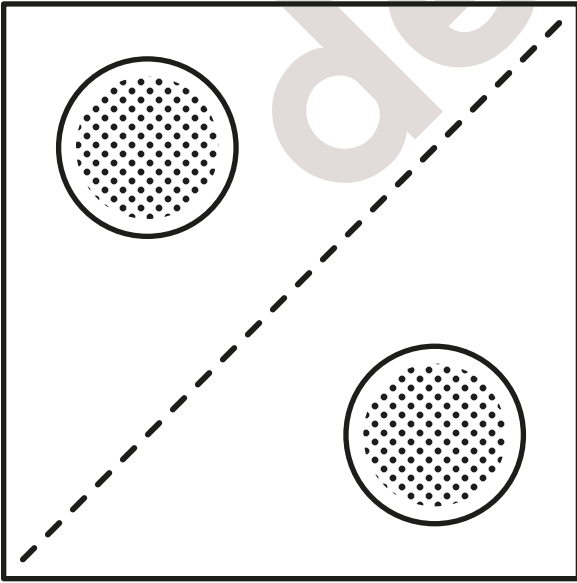

D

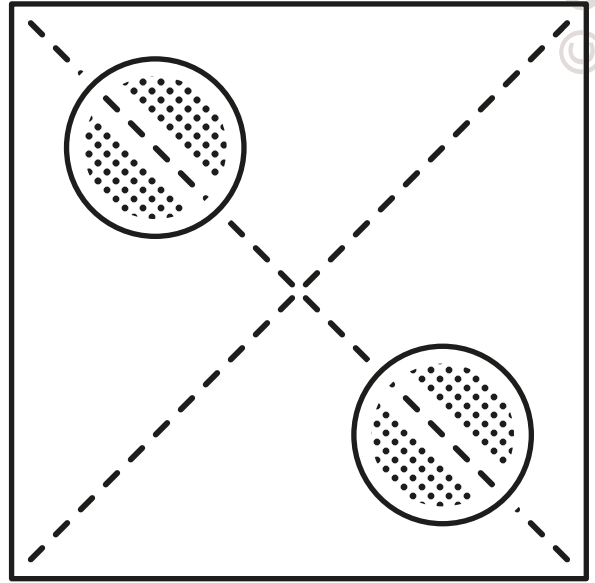

Dit is een inzage-exemplaar. Kopiëren en vermenigvuldigen is niet toegestaan.  
Deze teksten zijn auteursrechtelijk beschermd. Het kopiëren van deze teksten is strafbaar.  
© Dedicon. De afbeeldingen zijn auteursrechtelijk beschermd. Het kopiëren van deze afbeeldingen is strafbaar.  
voor leerlingen met een visuele beperking op <https://educatief.dedicon.nl>

dedicon



8.  
A

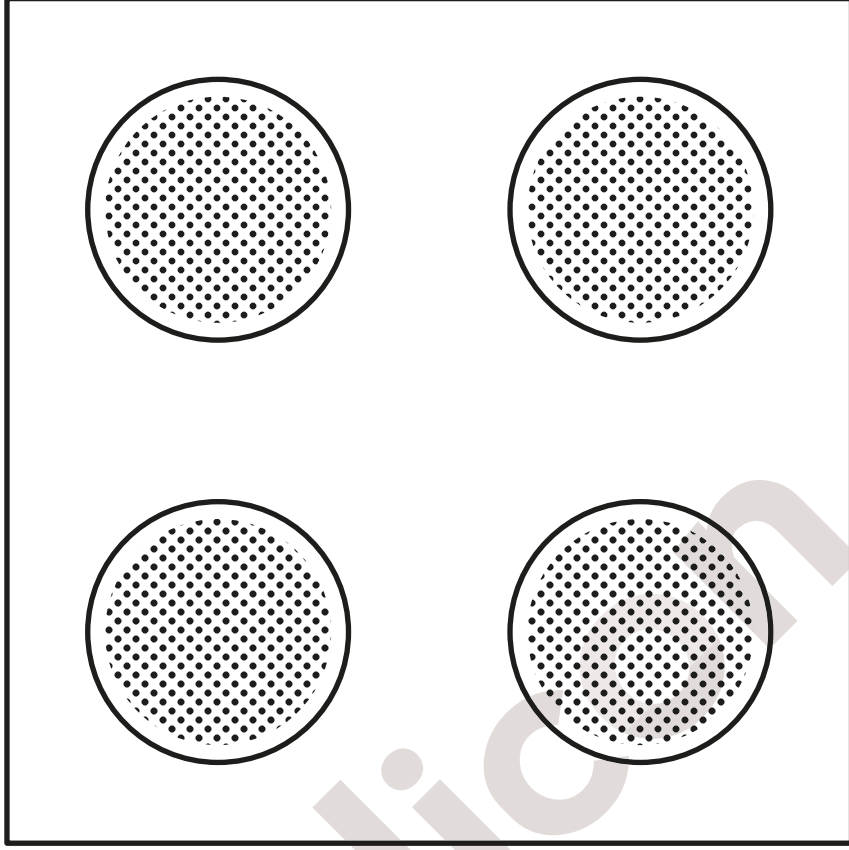

B

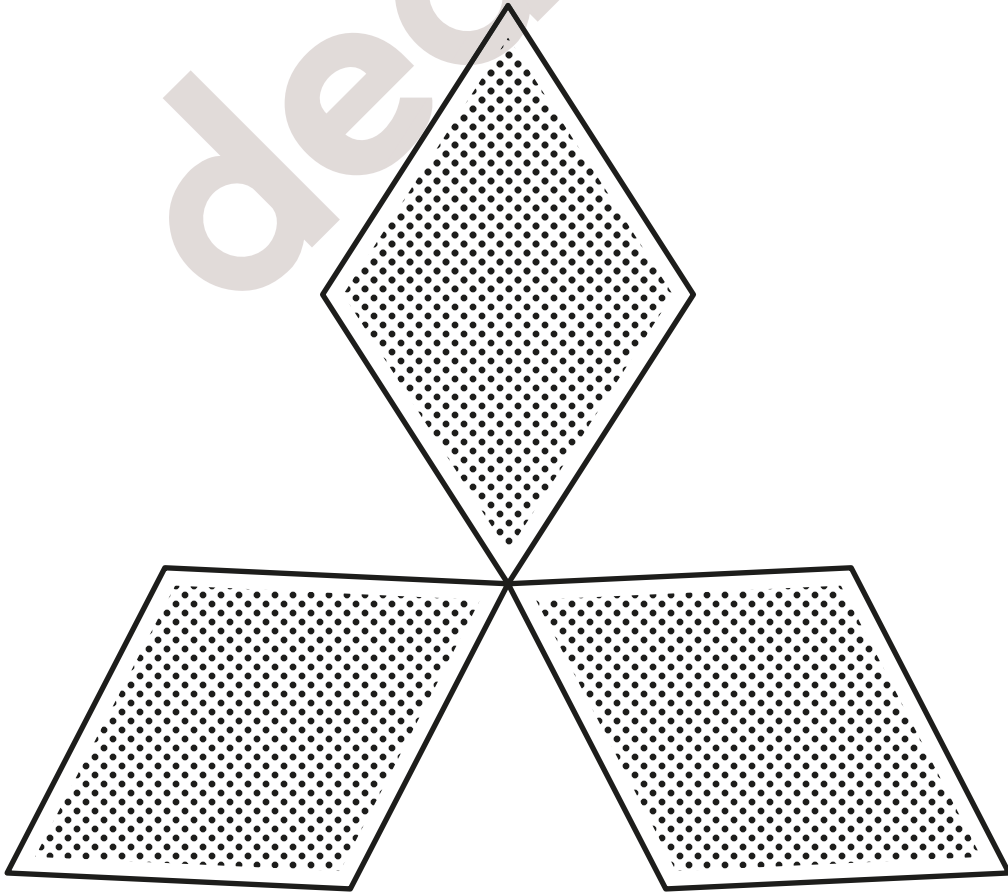

Dit is een inzage-exemplaar. Kopiëren en vermenigvuldigen is niet toegestaan.  
Deze tekening komt uit een Op de Tast boek, uitsluitend te bestellen door of  
voor leerlingen met een visuele beperking op <https://educatief.dedicon.nl>

© dedicon

9.  
A

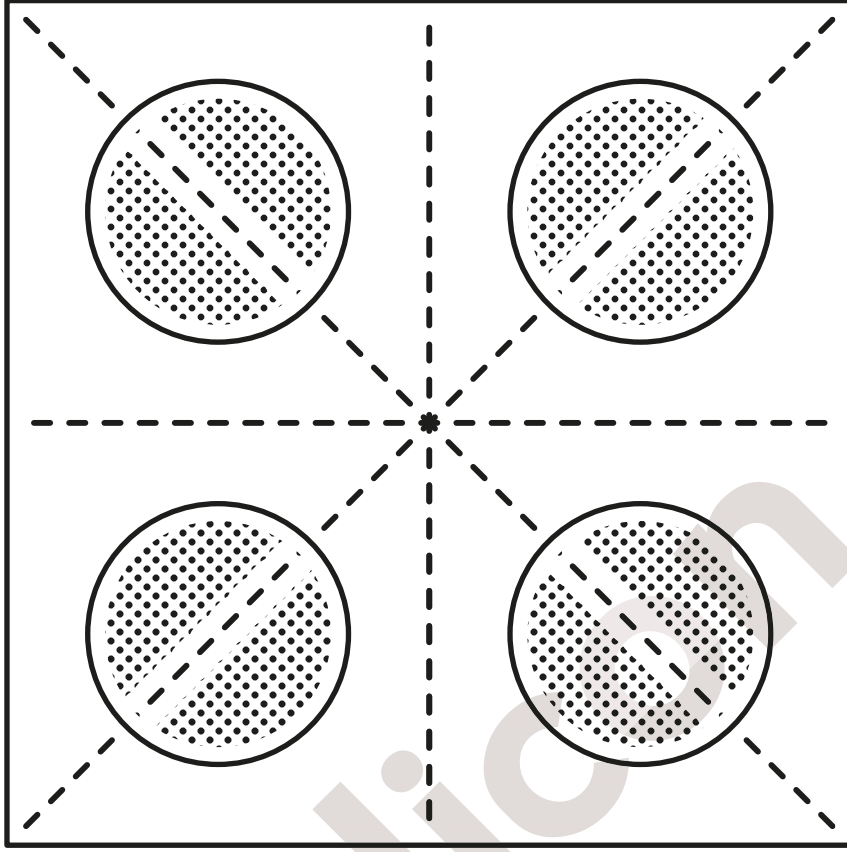

B

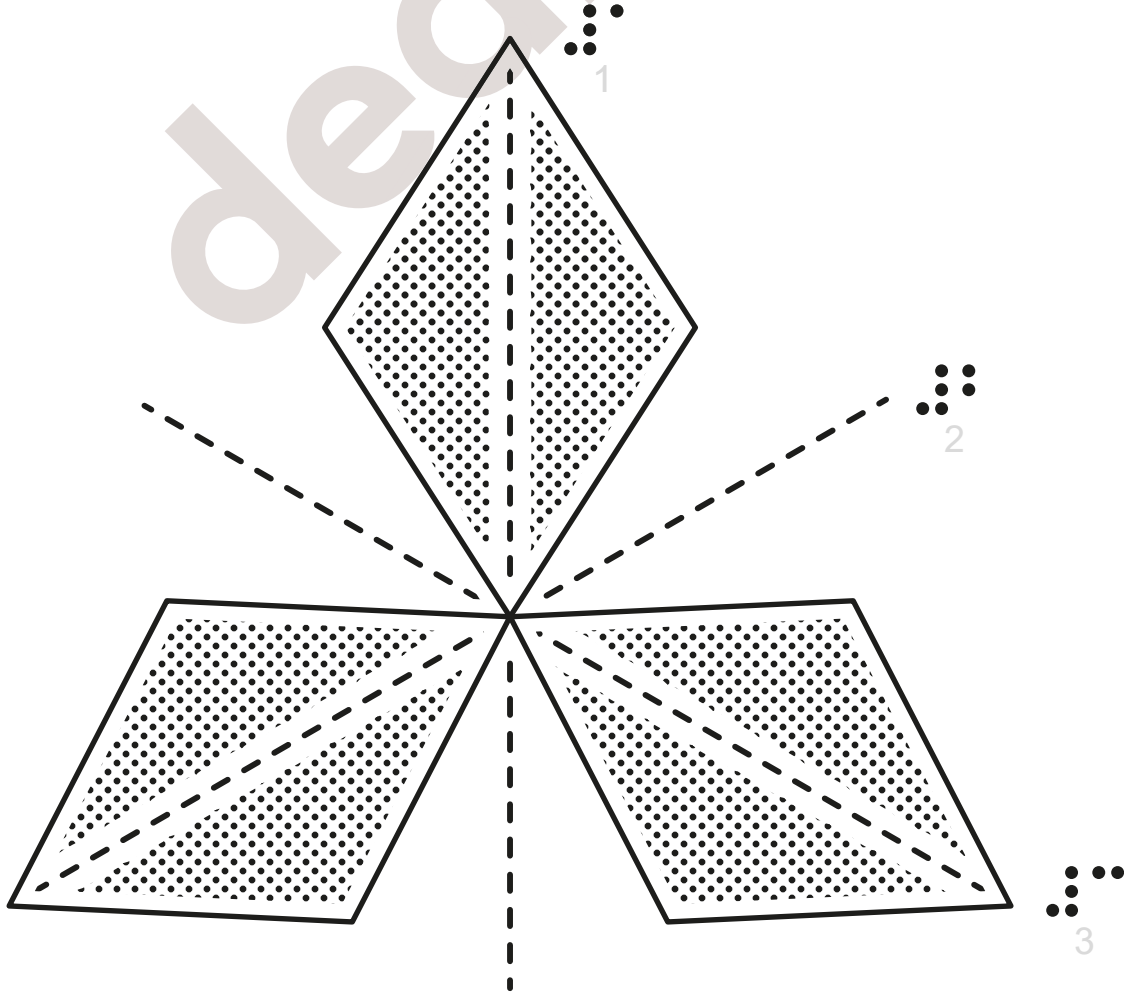

Dit is een inzage-exemplaar. Kopiëren en vermenigvuldigen is niet toegestaan.  
Deze tekening komt uit een Op de Tast boek, uitsluitend te bestellen door of  
voor leerlingen met een visuele beperking op <https://educatief.dedicon.nl>

© dedicon

10.  
A

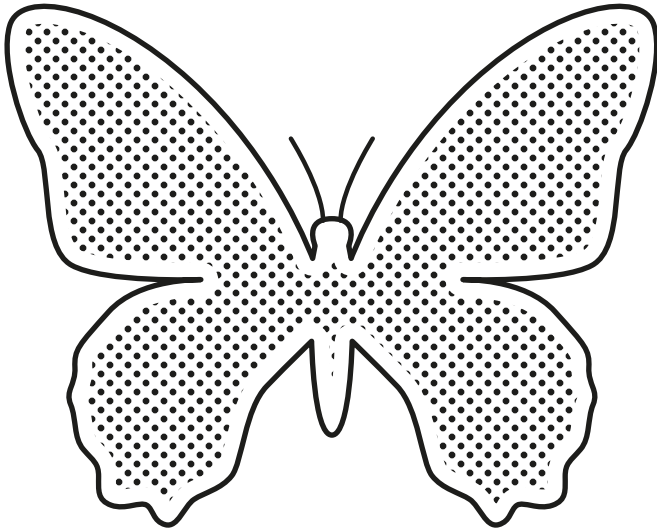

B

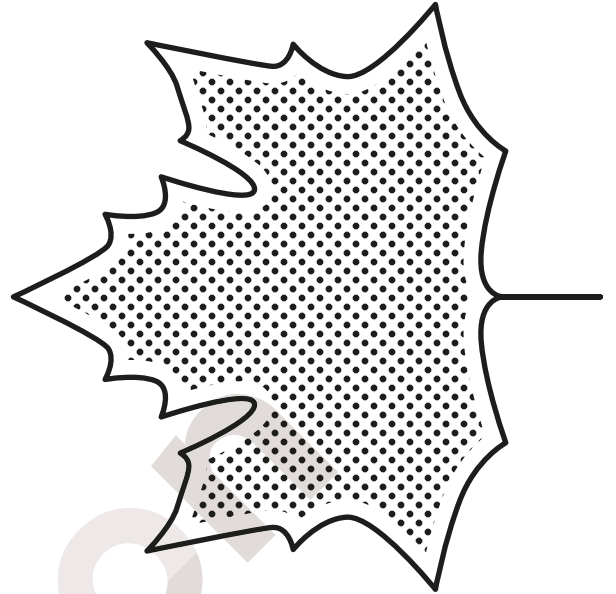

C

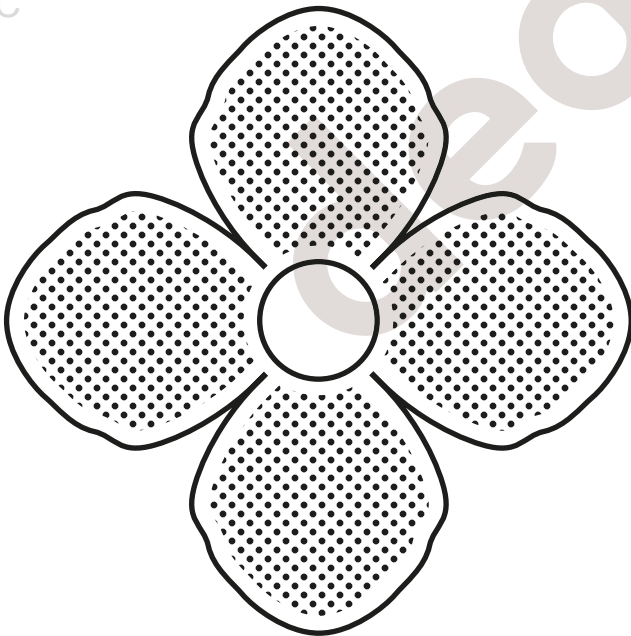

D

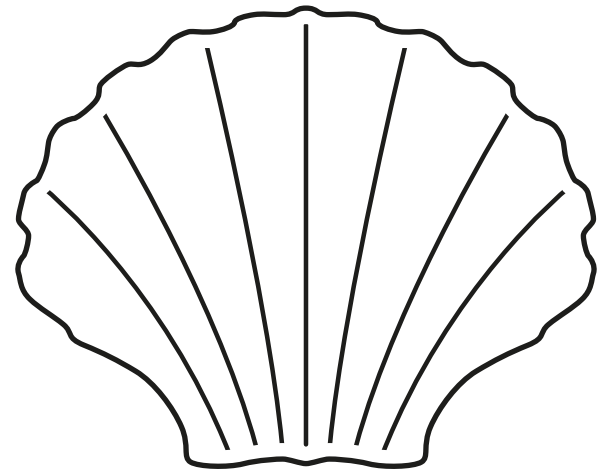

11.  
A

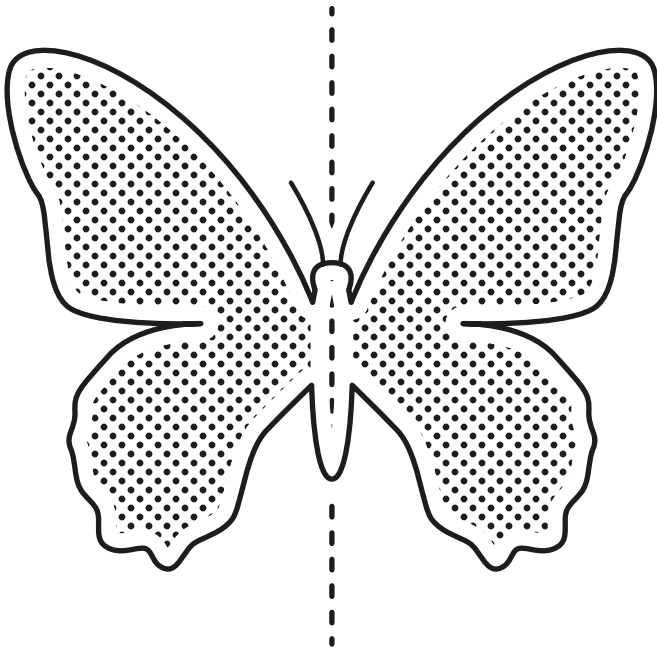

B

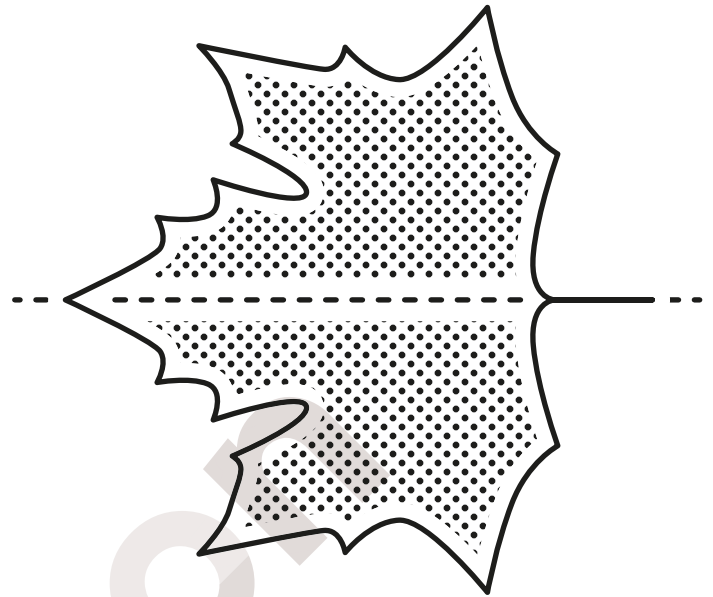

C

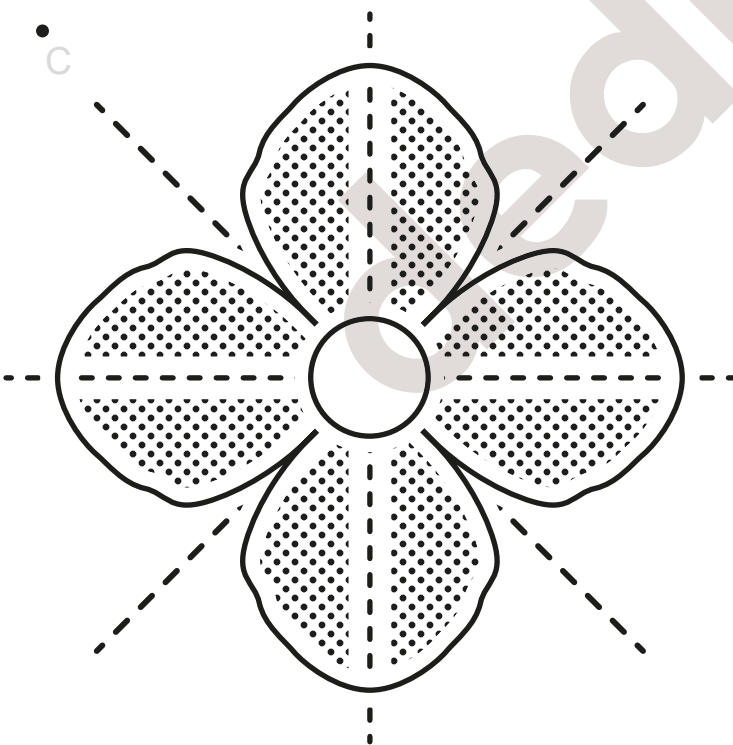

D

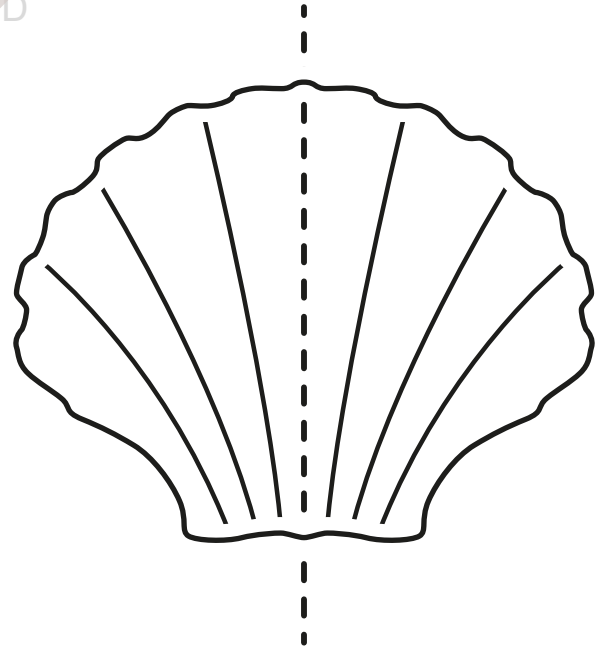

12.  
A

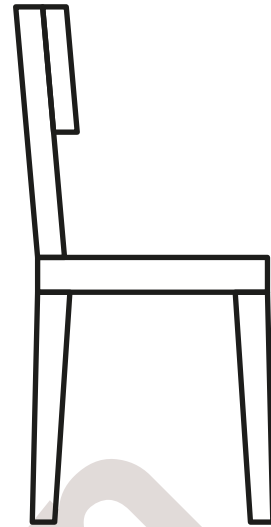
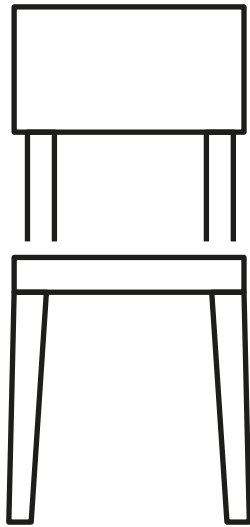

B

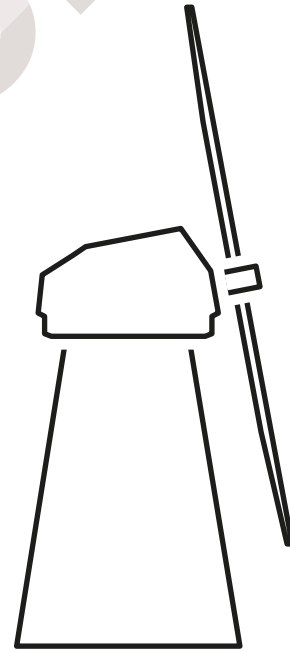
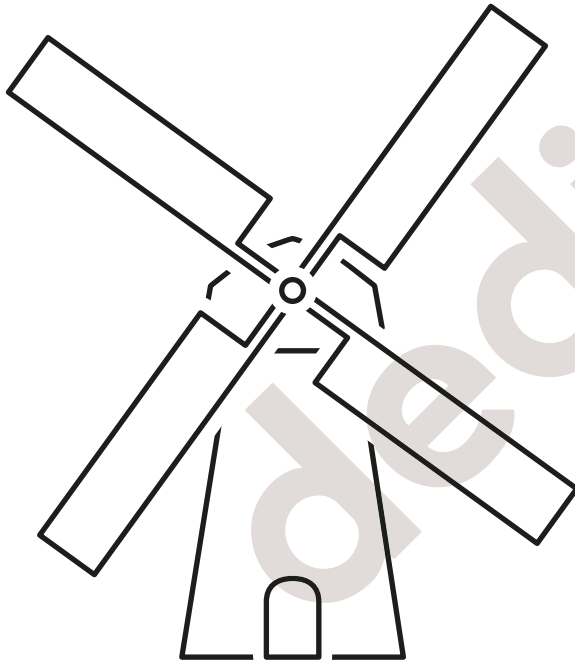

C

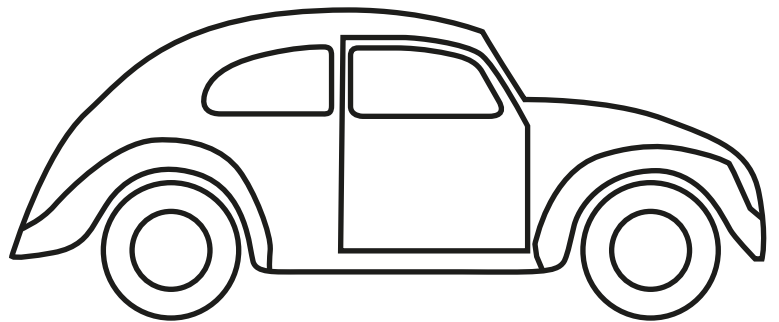
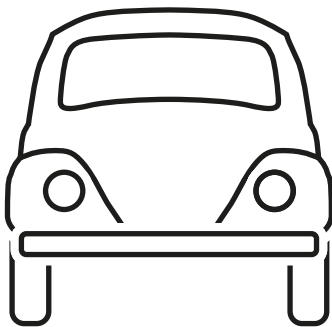

13.  
A

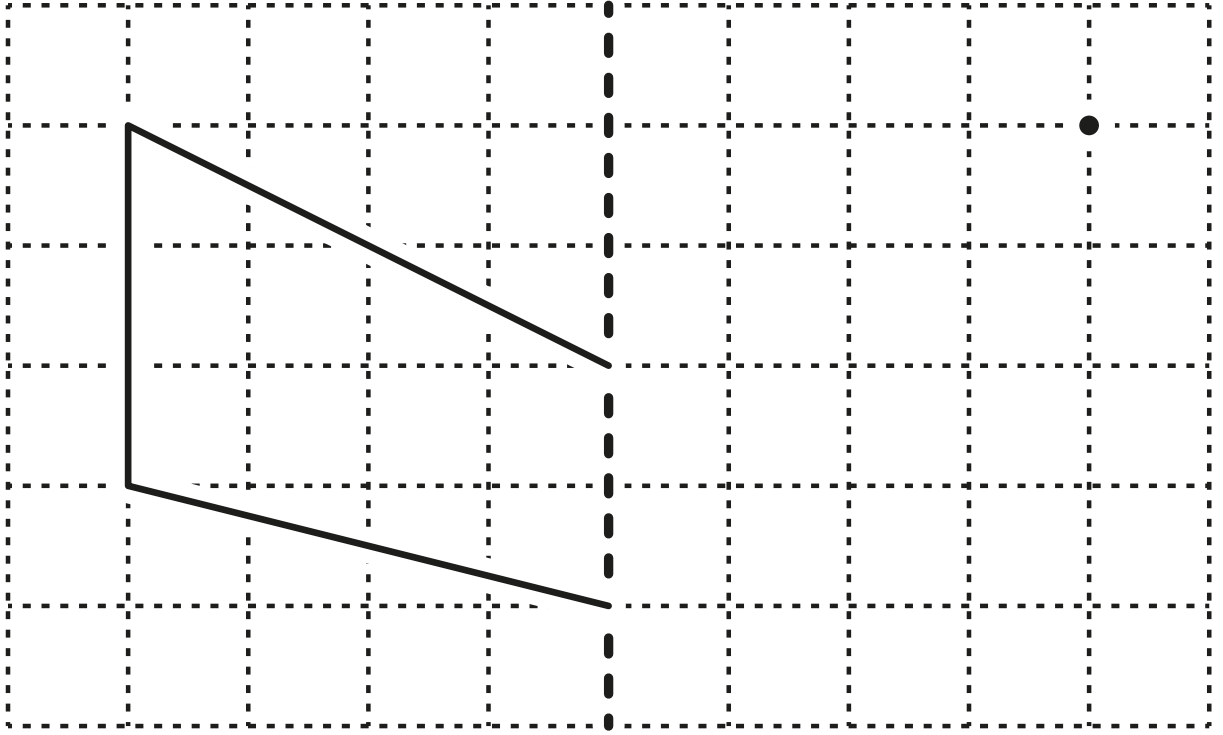

B

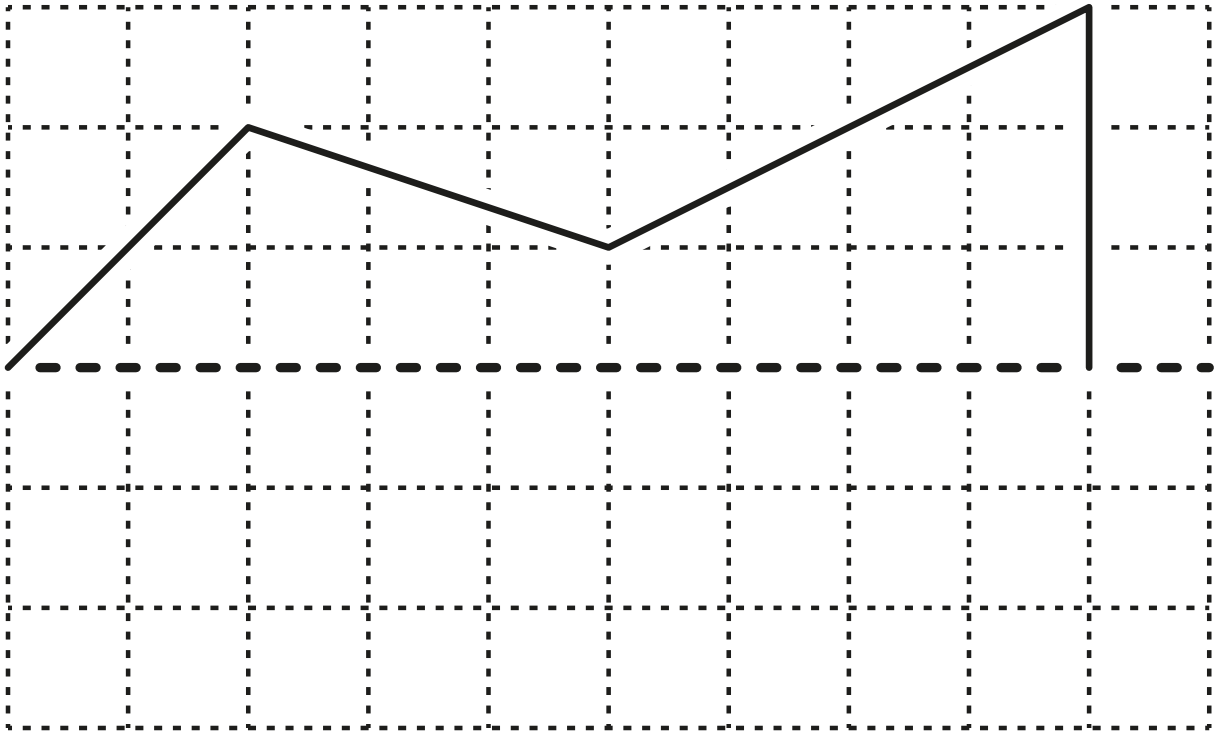

14.  
A

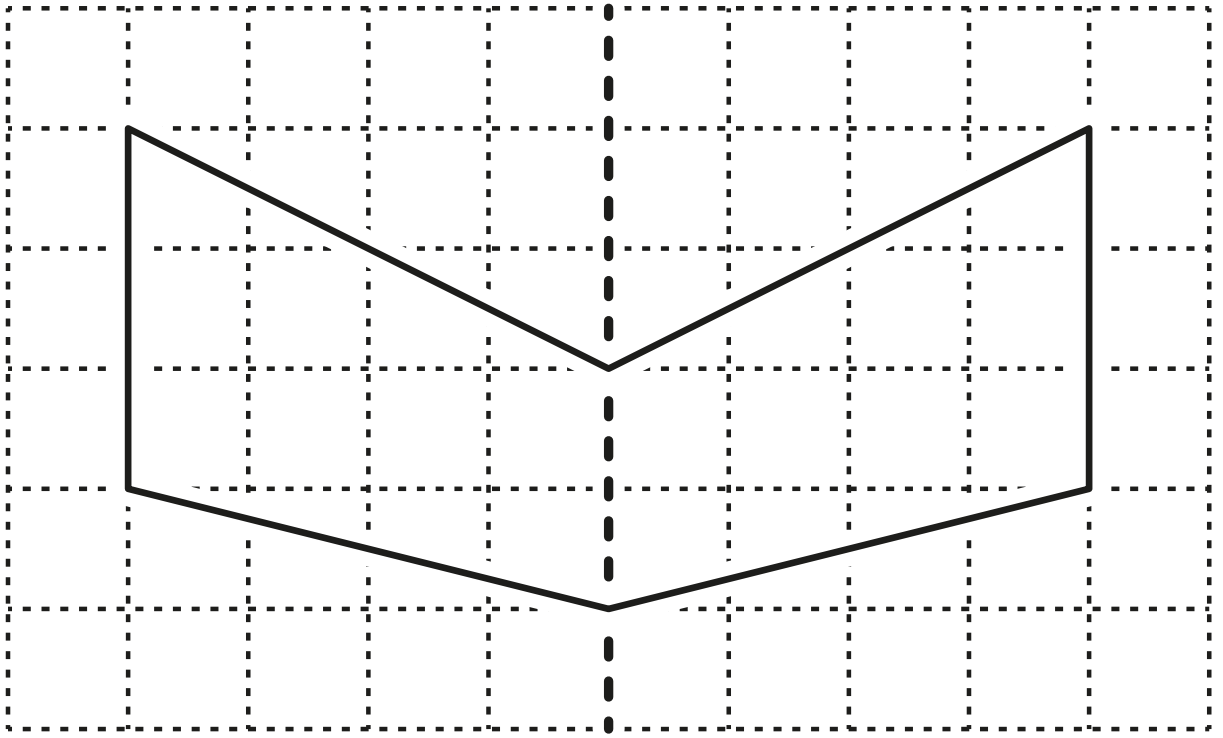

B

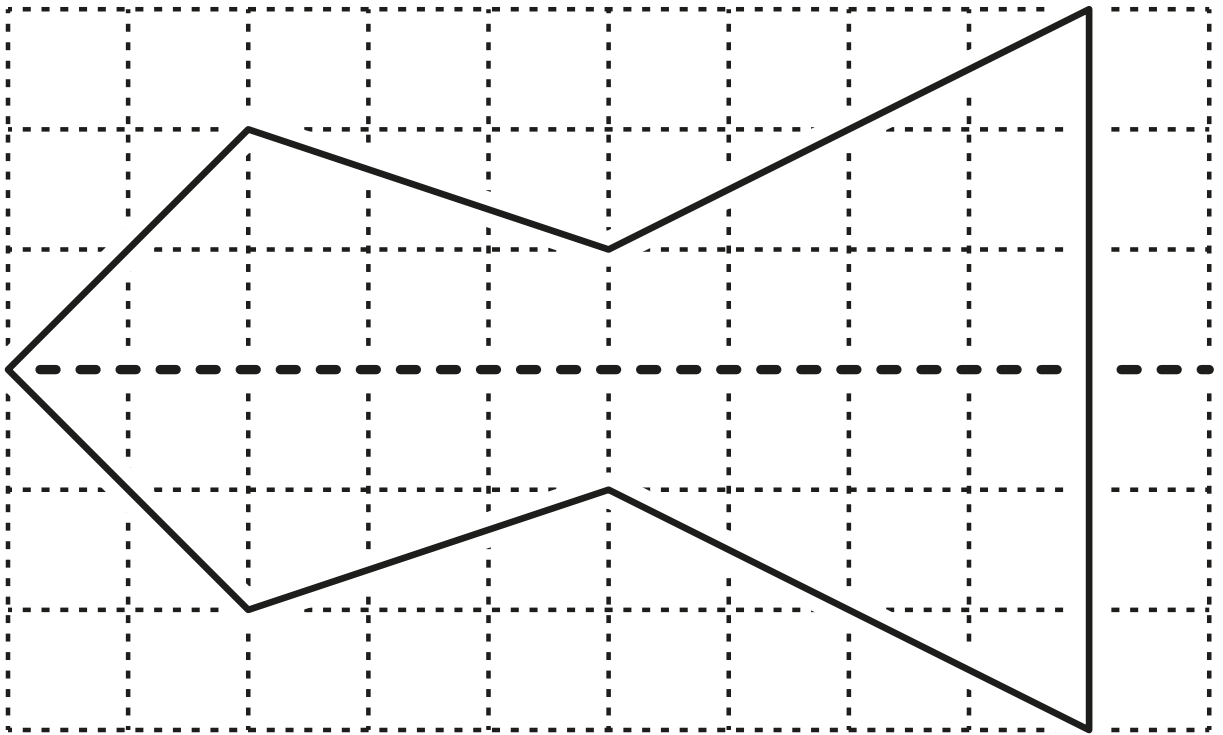

15.  
A

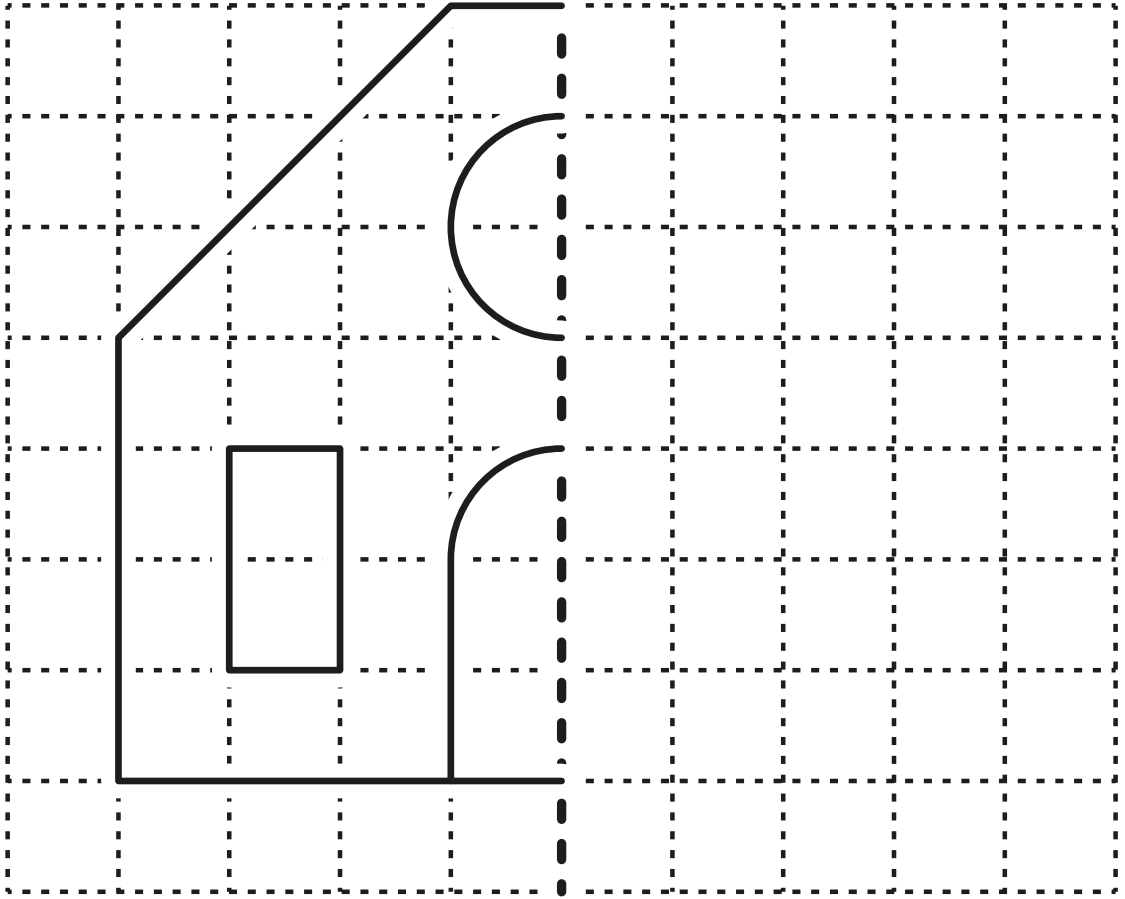

B

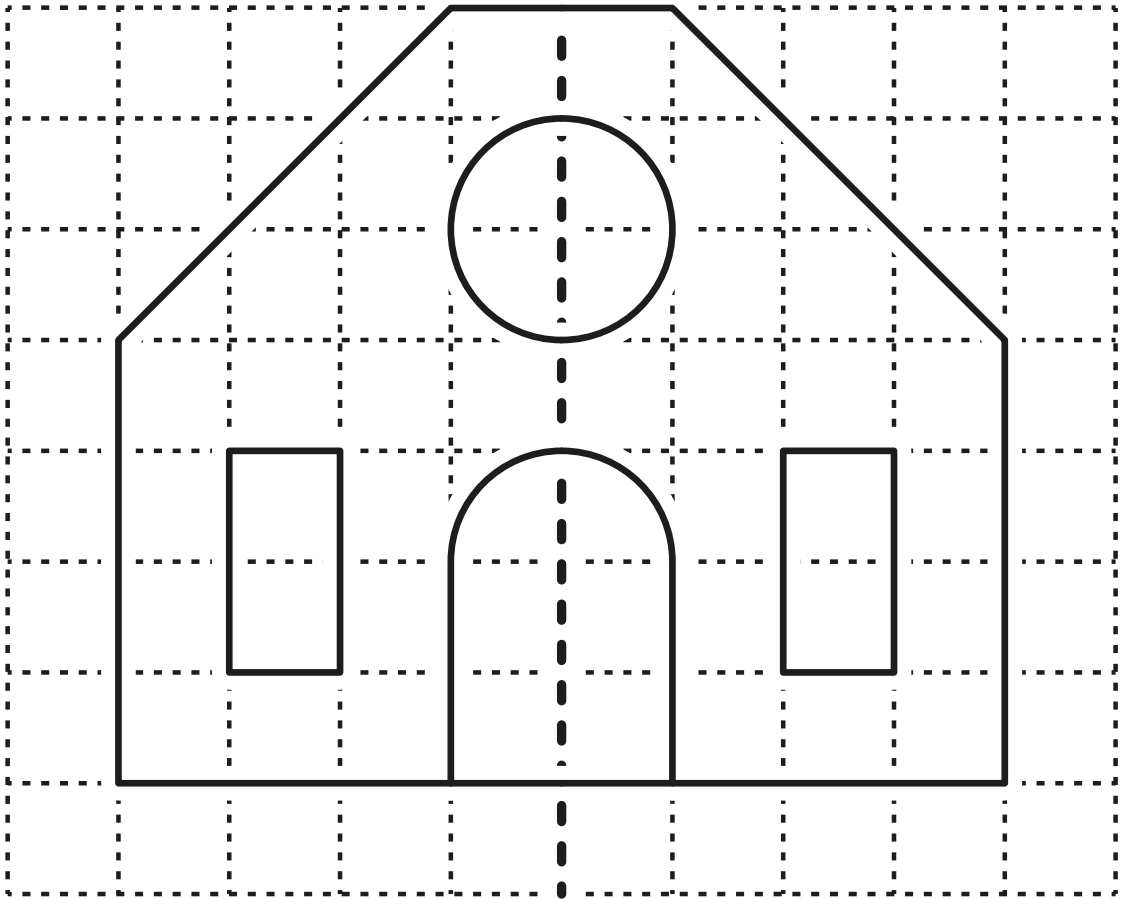





16.

A

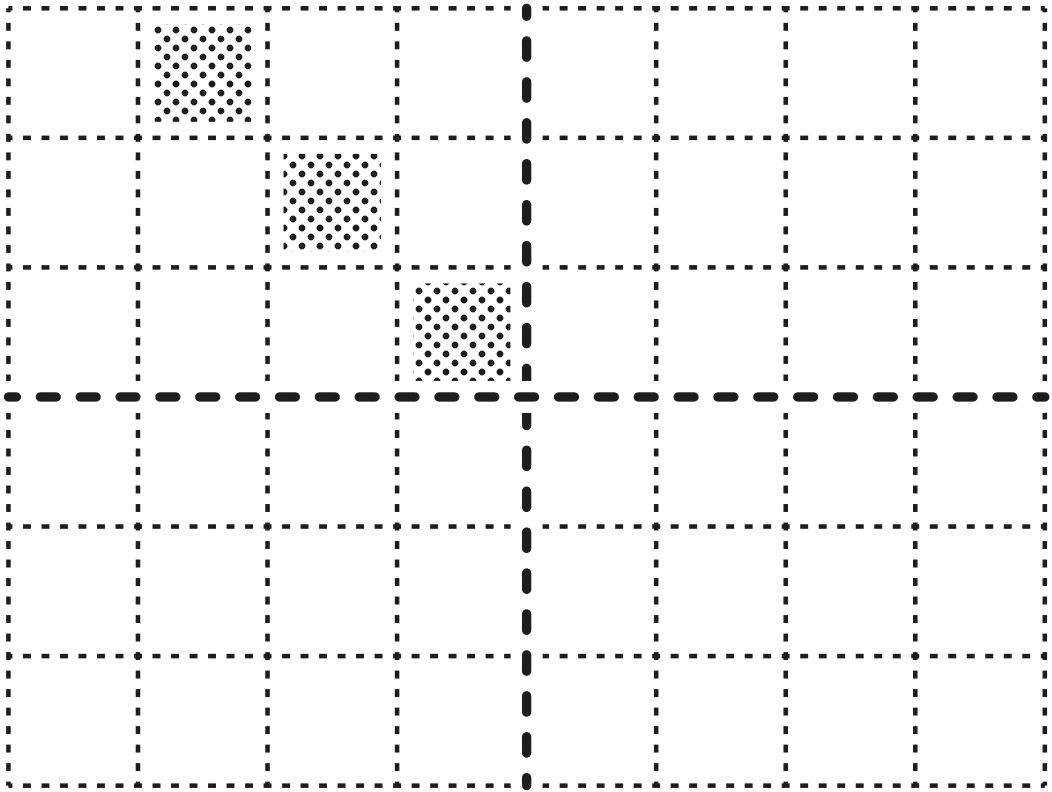

B

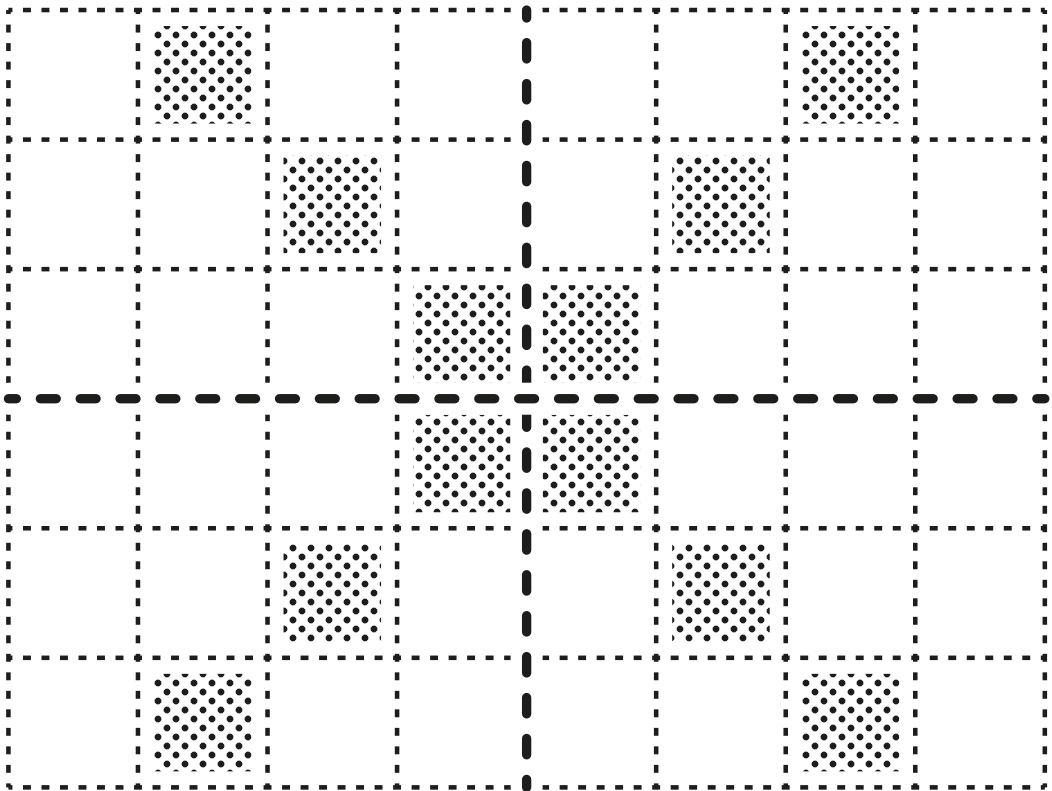

17.  
A

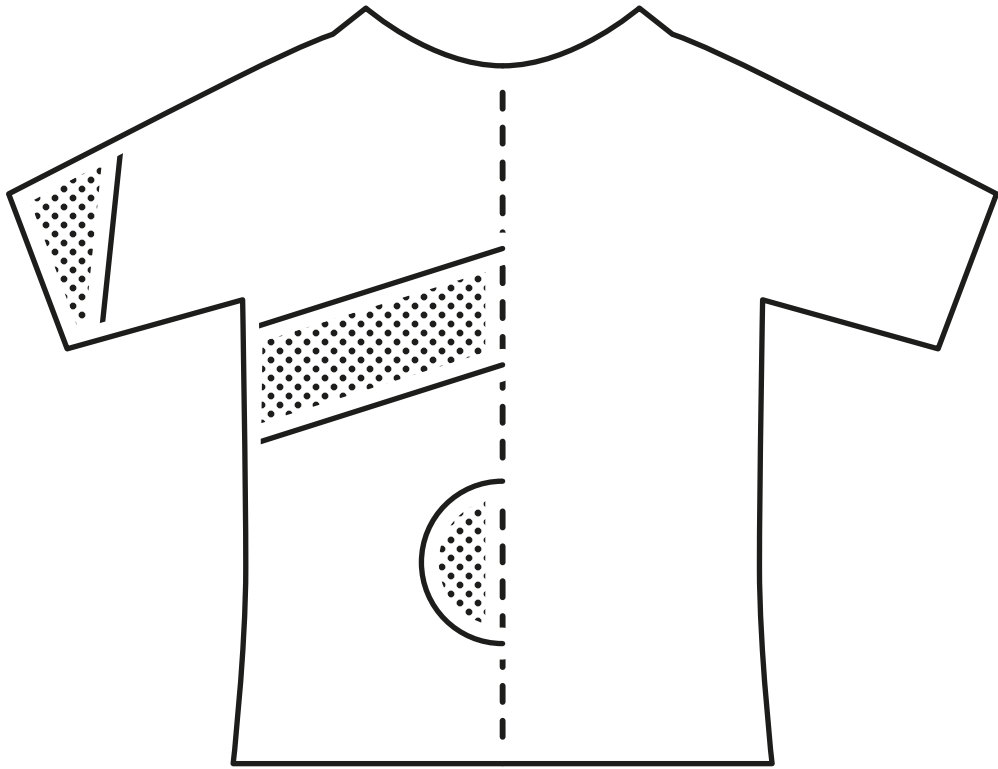

B

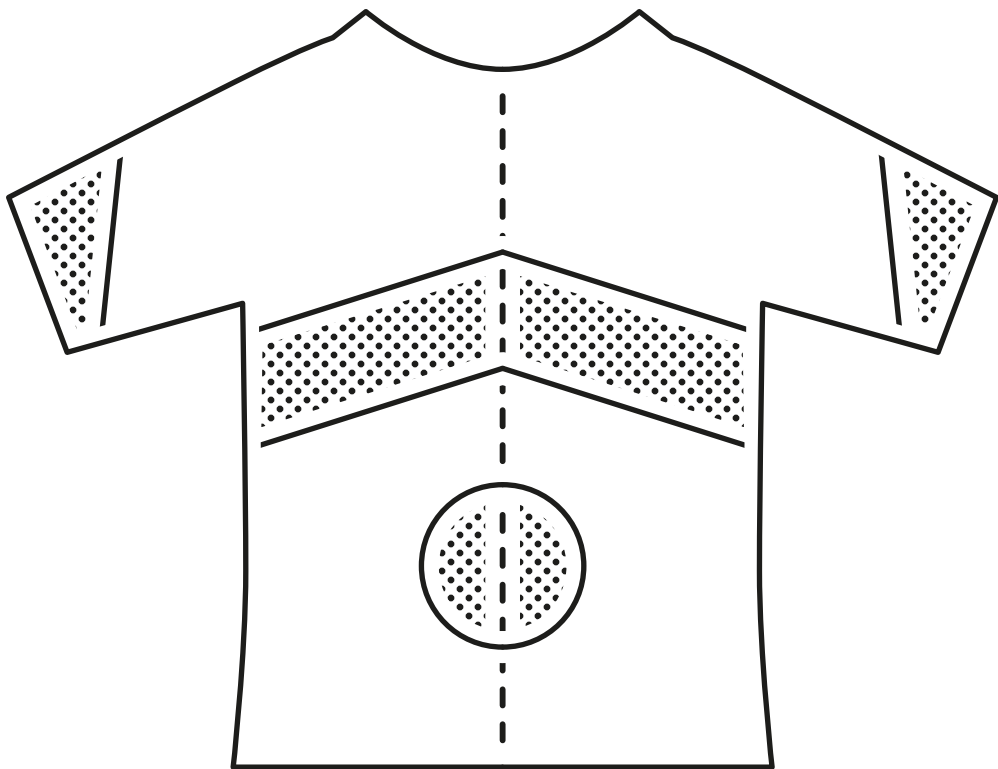

18.  
A

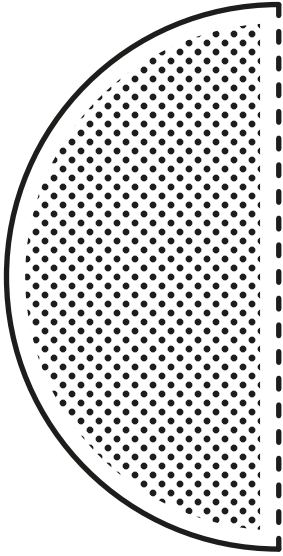

1

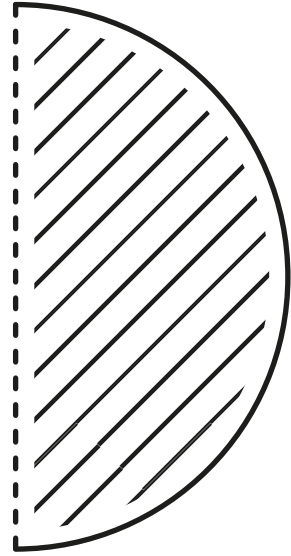

B

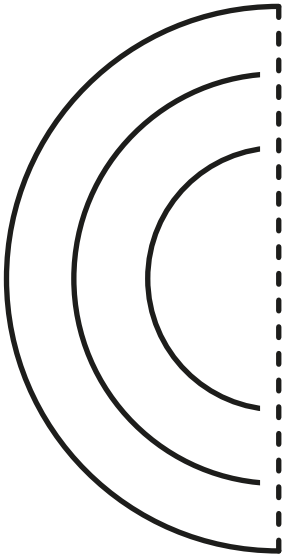

2

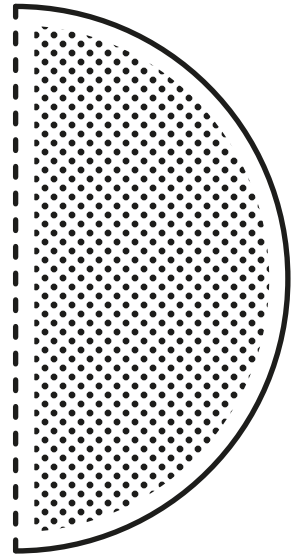

C

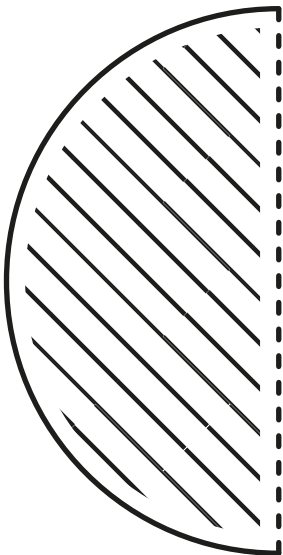

3

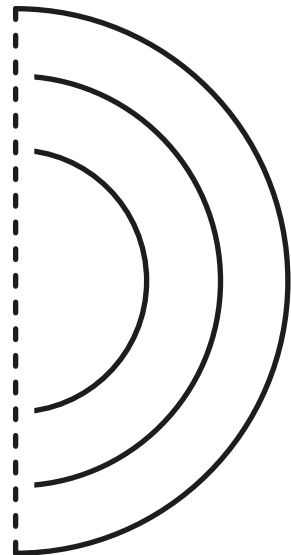

19.  
A

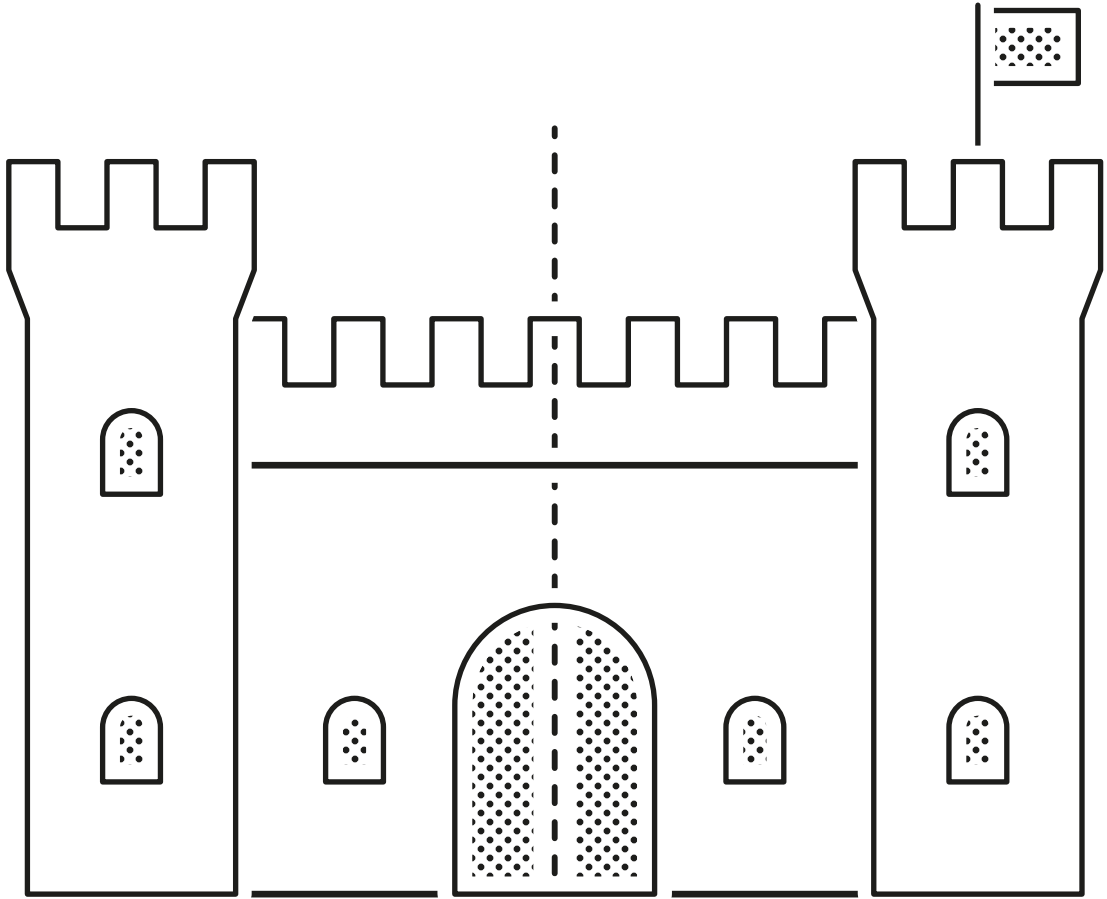

B

